

# BUS

Wired electro-installation





---

**ELKO EP**

---

**ELKO EP have been your partner in the field for 30 years, developing and manufacturing the highest quality electronic devices for electroinstallation as well as smart system for residential and building automation.**

ELKO EP employs more than 330 people across 15 foreign branches and exports its products to more than seventy countries. Company of the Year, Visionary of the Year, Superbrands and Global Exporter of the Year are just some of the awards we have received throughout the years as we consistently strive to move forward in the field of innovation and development.

Millions of relays, thousands of smart homes, hundreds of buildings and many satisfied customers - This is ELKO EP; a traditional company based in the center of Europe, where own development, production, logistics, and service are at the forefront of our focus.

# Facts and stats

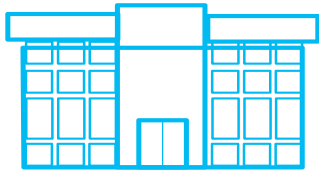

**30 %**

Czech

**40 %**

export

**30 %**

branches



## WORLDWIDE

11 branches  
6 franchises  
70 export countries

**350**

employees  
in holding

**30 000 +**

iNELS  
installations

**30 000 000 +**

manufactured  
products

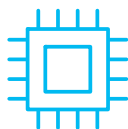

## R&D

continuosly  
innovative

## MANUFACTURER

fully automated  
complete proces

## SUPPORT

24 / 7 / 365

**World leader**  
in DIN rail relays production

Revolutionizing building automation: Exploring the new iNELS bus architecture .....	6
iNELS topology .....	8
Overview of system units .....	10

### Central units

CU3-07M   Central unit with 1x BUS .....	14
CU3-08M   Central unit with 2x BUS .....	15
CU3-09M/DALI   Central unit with 1x BUS, 1x DALI - <b>NEW!</b> .....	16
CU3-10M   Central unit with 1x BUS, 1x MODBUS - <b>NEW!</b> .....	17

### System units

PS3-30/iNELS   Power supply with BUS separator .....	18
BPS3-01M, BPS3-02M   Bus separator from power supply .....	19
PSM3-30/iNELS, PSM3-60/iNELS, PSM3-100/iNELS   Power supplies for iNELS BUS .....	20

### Detectors | sensors

MCD3-1   Ultra slim microwave motion detector - ceiling mount - <b>NEW!</b> .....	22
PMS3-1   Ultra slim PIR motion detector - ceiling mount - <b>NEW!</b> .....	23
DLS3-1   Light intensity sensor .....	24

### Converters

ADC3-60M   Analog-to-digital converter, 6 inputs .....	26
DAC3-04M   Digital-to-analog converter, 4 outputs .....	27

### Switching actuators

SA3-01B, SA3-02B   Switching actuator, 1 channel and 2 channels .....	28
SA3-04M   Switching actuator, 4 channels .....	29
SA3-06M   Switching actuator, 6 channels .....	30
SA3-014M   Switching actuator, 14 channels - <b>NEW!</b> .....	31
SA3-014M/E   Switching actuator, 14 channels - <b>NEW!</b> .....	32
SA3-022M   Switching actuator, 22 channels .....	33
EA3-022M   Switching actuator without controls and indicators, 22 channels .....	34

### Shutter actuators

JA3-014M   Shutter actuator, 14 channels - <b>NEW!</b> .....	35
JA3-014M/E   Shutter actuator, 14 channels - <b>NEW!</b> .....	36

### Lighting control

DA3-22M   Universal dimming actuator, 2 channels .....	37
DA3-66M   Dimming actuator, 6 channels .....	38
DA3-03M/RGBW   Dimming actuator for RGBW strips .....	39

### Input units

IM3-40B, IM3-80B   Binary input units, 4 inputs and 8 inputs .....	40
IM3-140M   Binary input unit, 14 inputs .....	41
TI3-40B   Temperature input, 4 inputs .....	42
TI3-60M   Temperature input, 6 inputs .....	43

### Combined units

RC3-610M/DALI   Room controller with DALI dimmer - <b>NEW!</b> .....	44
FA3-612M   Fancoil controller .....	45
IOU3-108M   Universal unit with 10 inputs and 8 outputs .....	46

**Wall controllers**

WSB3-20, WSB3-20H | Wall switch button, 2 buttons ..... 47  
 WSB3-40, WSB3-40H | Wall switch button, 4 buttons ..... 48  
 WMR3-21 | Wall card reader ..... 49

**Glass controllers**

GCR3-30, GCR3-230 | Glass card reader - **NEW!** ..... 50  
 GSB3-XX, GSB3-2XX | Glass switch buttons - **NEW!** ..... 52  
 GSB3-XX/S, GSB3-2XX/S | Glass switch buttons with symbols - **NEW!** ..... 54

**Icons configurator** ..... 56

**Metal controllers**

MSB3-40, MSB3-60, MSB3-90 | Metal switch buttons - **NEW!** ..... 58

**Thermo-regulators**

IDRT3-1 | Digital room thermo-regulator ..... 60  
 GRT3-70, GRT3-270 | Glass room thermo-regulator - **NEW!** ..... 61  
 GRT3-100 | Glass room thermo-regulator - **NEW!** ..... 62

**Inspinia touch units**

EST4 | 4" room controller panel - **NEW!** ..... 64  
 EST8 | 8" touch control panel - **NEW!** ..... 65  
 EST10 | 10" touch control panel - **NEW!** ..... 66  
 Add-ons ..... 67

**Integration**

iNELS Bridge | Third-party integration gateway - **NEW!** ..... 68  
 Connection Server II. | Third-party integration server ..... 69  
 MQTT | The Standard for IoT Messaging ..... 70

**Multimedia**

LARA Radio ..... 72  
 LARA Intercom ..... 73  
 LARA accessories ..... 74

**iNELS app** ..... 76

**Accessories iNELS**

TELVA-2 230V, TELVA-2 24V | Thermo-drive ..... 78  
 TC, TZ, Pt100 | Thermo sensors ..... 79

BUS electro-installation ..... 80  
 Product loadability ..... 81  
 Loadability of contacts ..... 82  
 Installation possibilities ..... 84  
 Dimensions ..... 86

In the rapidly evolving landscape of smart home and building automation, the iNELS Bus system is stepping into the spotlight with a groundbreaking new architecture. This innovative approach not only caters to the needs of independent units like villas and apartments but also scales seamlessly for large installations such as hotels and commercial buildings.

### Autonomy Redefined: MiniCU Family

The introduction of the MiniCU family marks a significant shift, where each bus operates as a fully autonomous unit. This not only simplifies the system's structure but also ensures continuous functionality even if communication with other units is lost. MiniCU, short for Mini central units (CU3-07M/08M/09M/10M), controls 1 or 2 buses, along with an additional bus for Dali/Modbus.

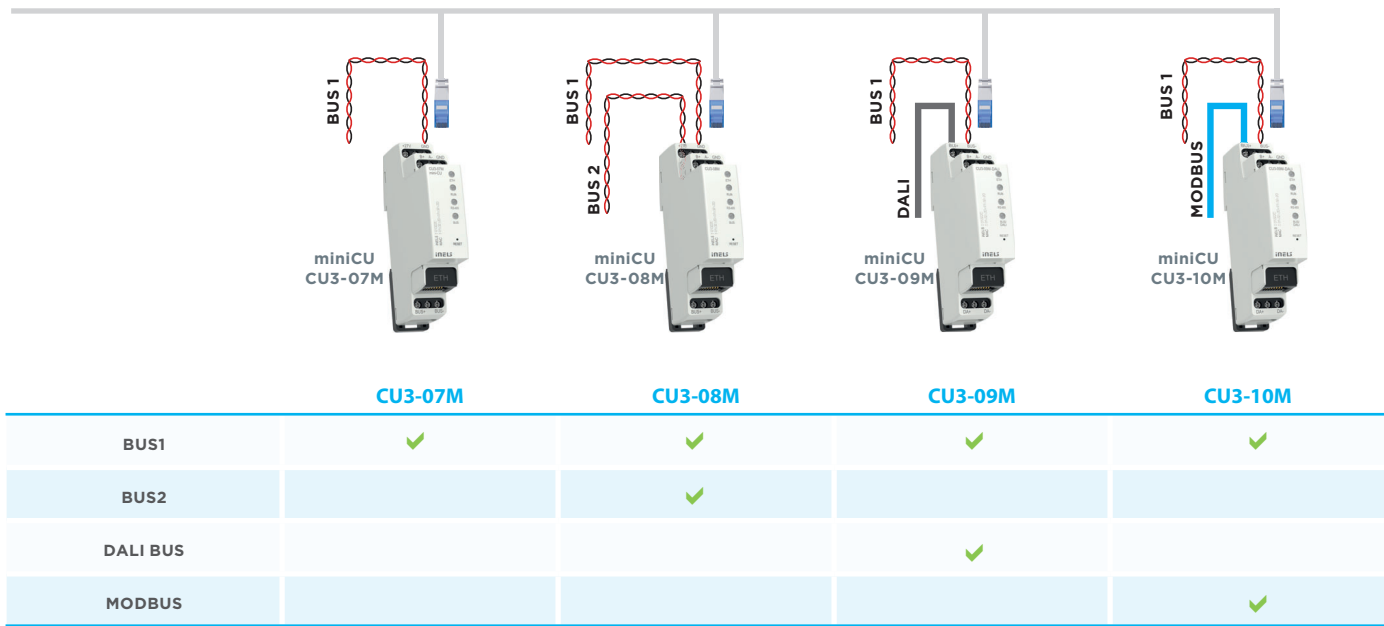

### Cloud Connectivity and Beyond

The new IP infrastructure elevates the iNELS Bus system to new heights. The connection to the central iNELS CLOUD system opens up possibilities for unlimited scaling. This cloud integration not only enables the coordination of units within a single installation but also facilitates inter-installation collaboration. Geographical barriers are broken down, allowing a control element in one location to manage devices in another, creating a truly interconnected network.

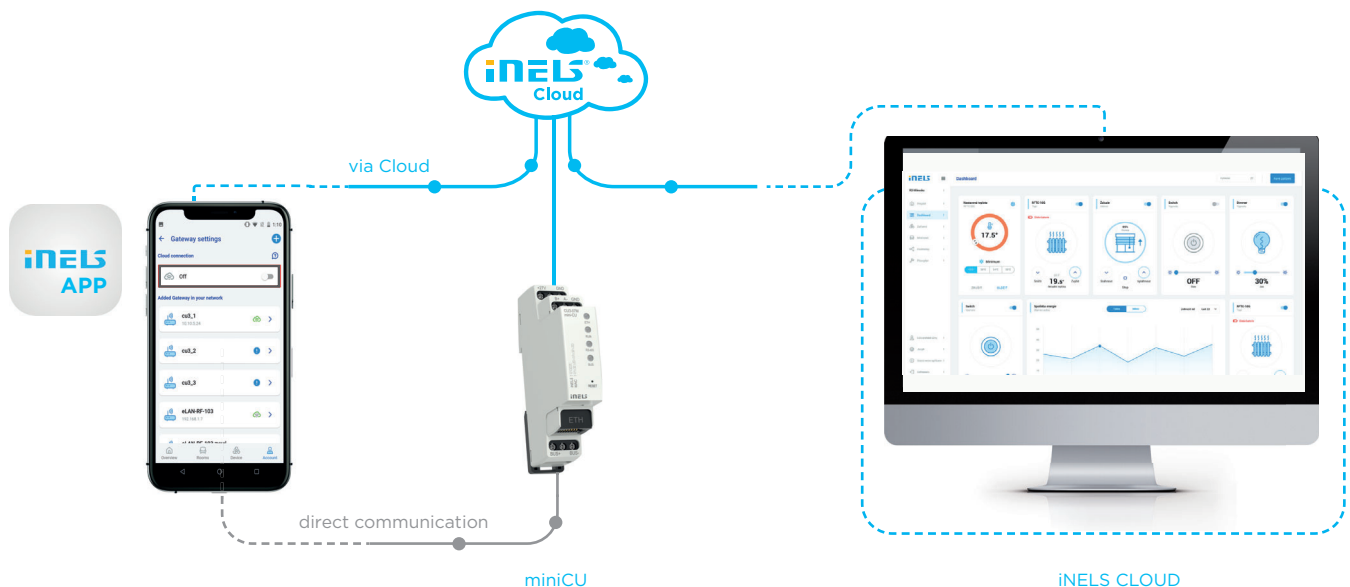

## Power and Data Efficiency with MQTT

One of the standout features is the implementation of MQTT communication in all central units. MQTT, renowned for its fast response time, simplifies integration and control across the entire iNELS system with the 3rd Party world. This industry-standard protocol ensures efficient interaction between devices, regardless of the number in operation. The use of MQTT extends beyond the central units, reaching into both wired and wireless solutions, contributing to the overall energy efficiency and responsiveness of the system.

## iNELS Bridge: Opening Doors to Third-Party Integration

Expanding its horizons, the new IP infrastructure includes the iNELS Bridge—a third-party integration control unit. This unit adds versatility by allowing almost the entire iNELS portfolio to be integrated, along with third-party devices using the Home Assistant platform. The pre-installation of MQTT broker and Home Assistant server for 3rd party integration makes iNELS Bridge not just a bridge but a comprehensive solution ready for diverse third-party integrations.

## Centralized Control for Large Installations: Seamless Integration with Home Assistant and NodeRED

The iNELS Bus system recognizes the need for centralized control in large installations. This central control system acts as a hub, connecting and monitoring various iNELS devices, from sensors to controllers. The integration of communication protocols like MQTT and IP facilitates seamless data exchange, fostering a synchronized and harmonious operation. This adaptability of iNELS extends further with seamless integration capabilities with popular platforms like Home Assistant and NodeRED. This integration opens up a world of possibilities, allowing users to incorporate iNELS devices and functionalities into their existing smart home ecosystems. Whether it's custom automations, advanced scripting, or creating complex flows, the combination of iNELS with Home Assistant and NodeRED adds a layer of customization and control for users seeking a personalized smart home experience.

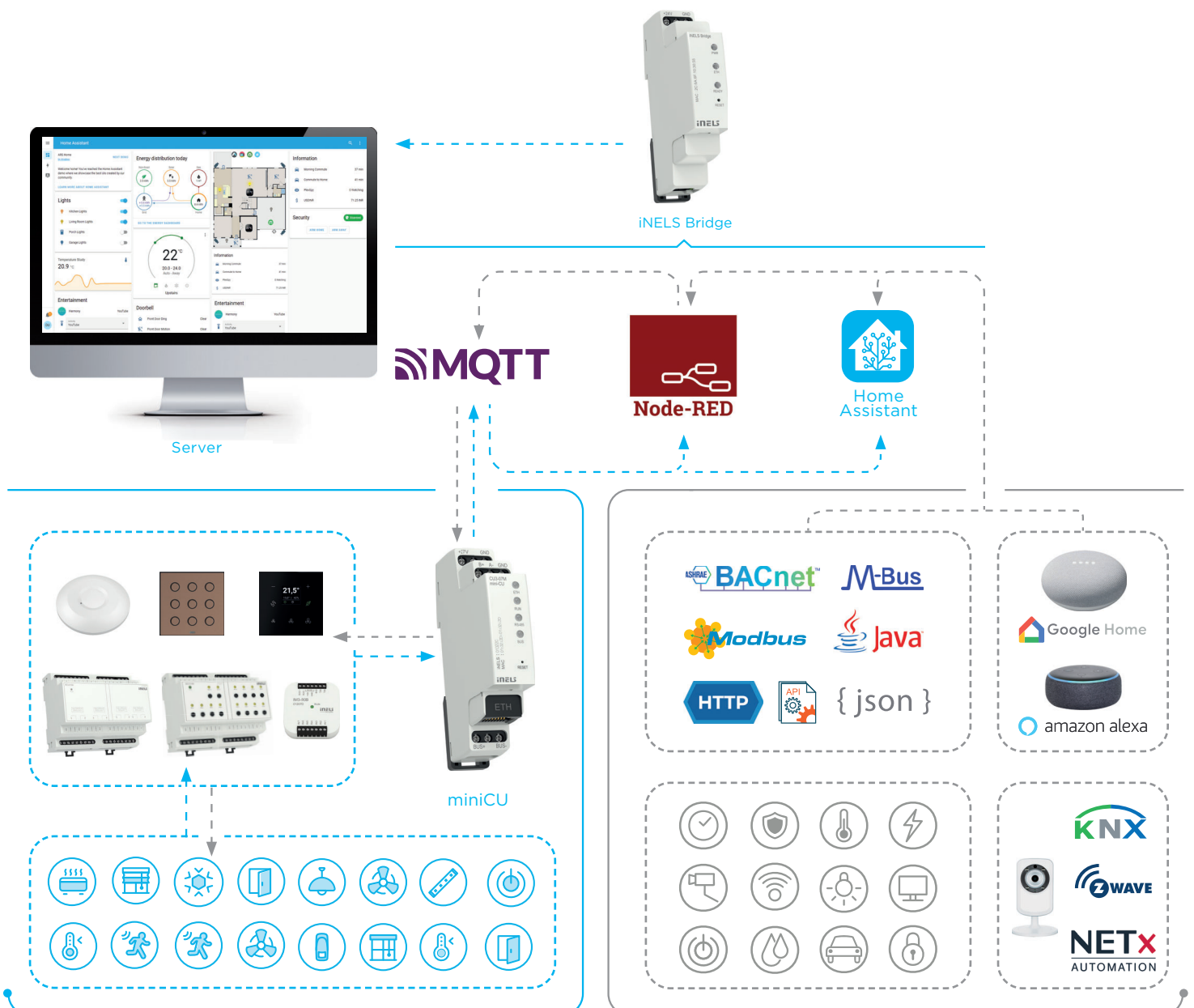

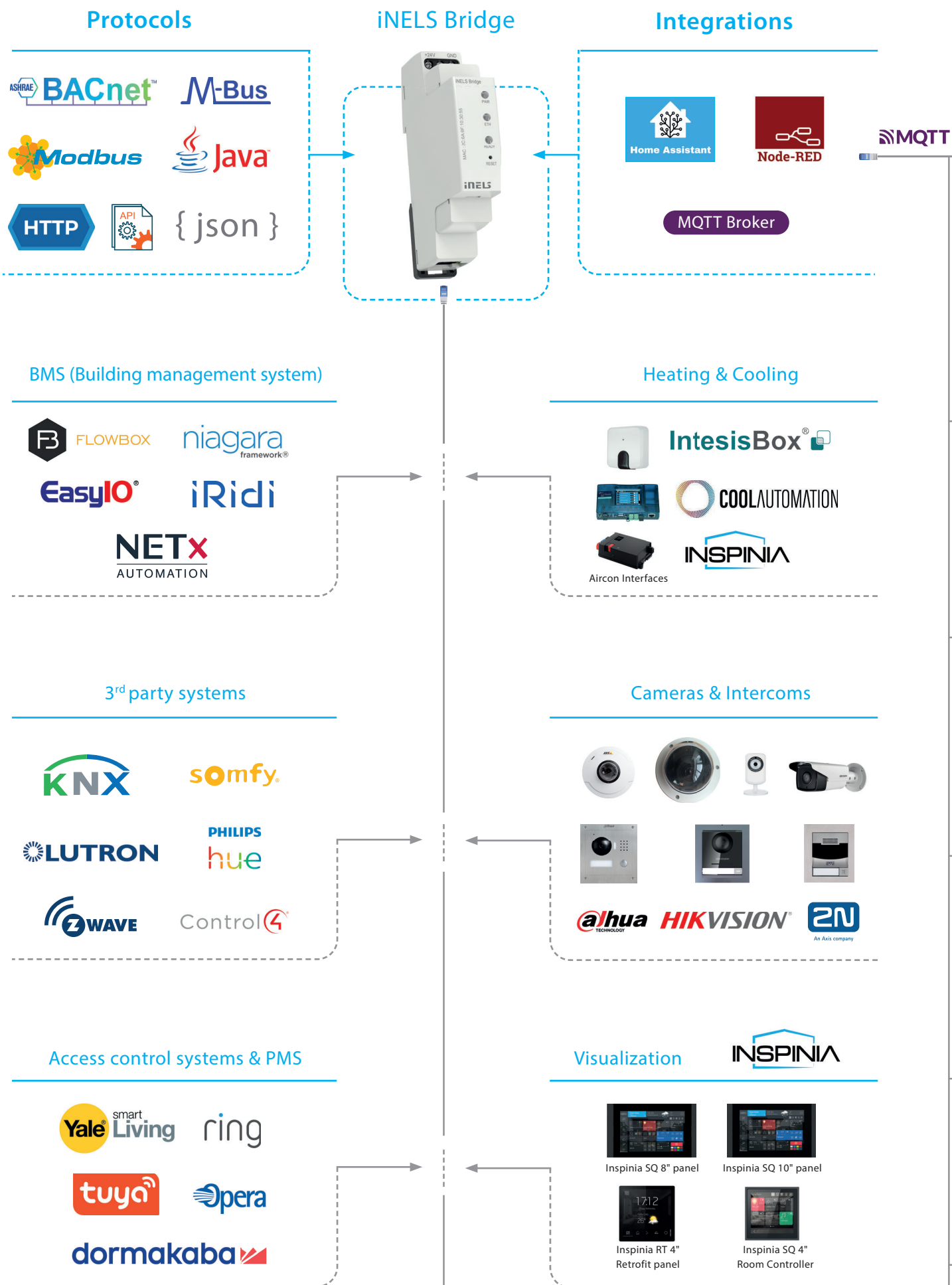



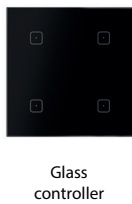
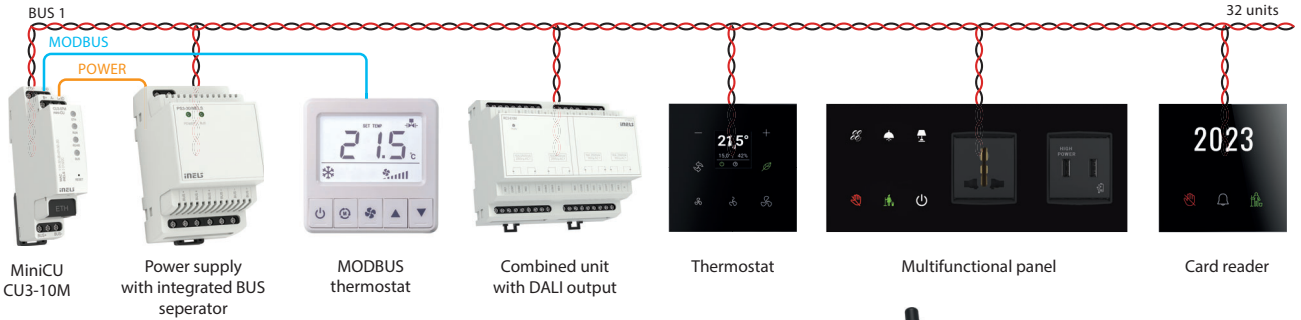
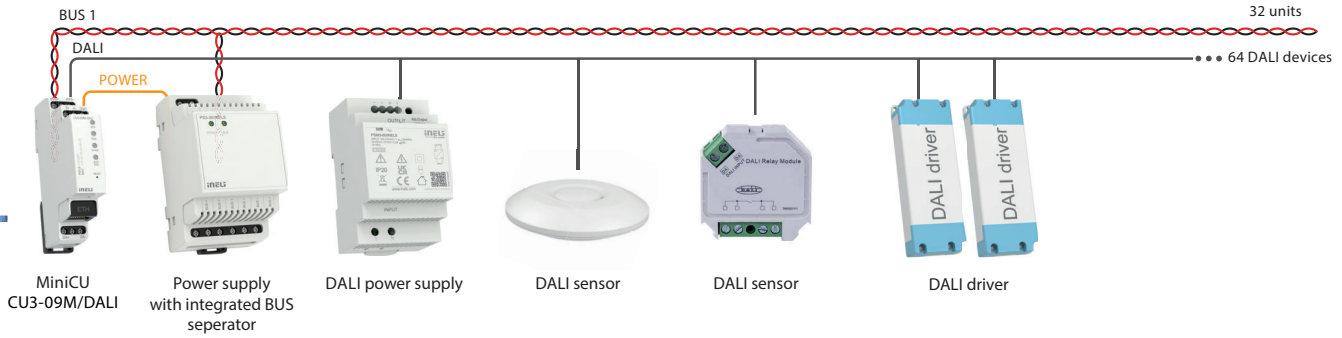
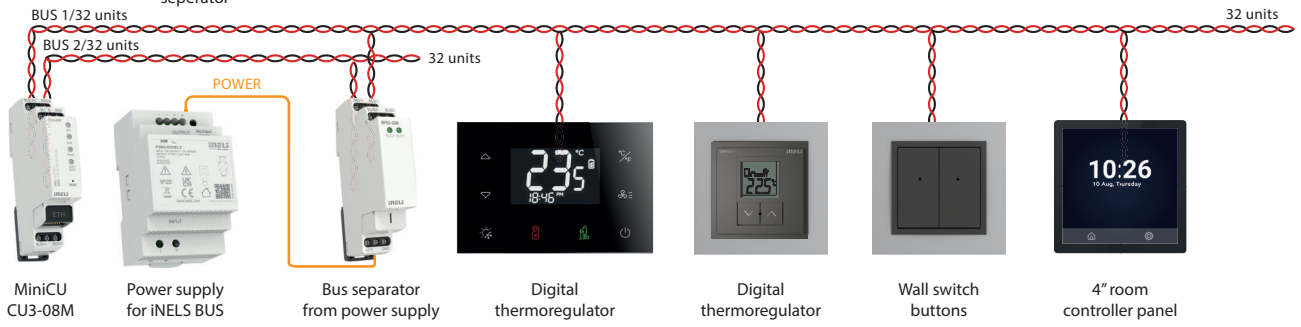
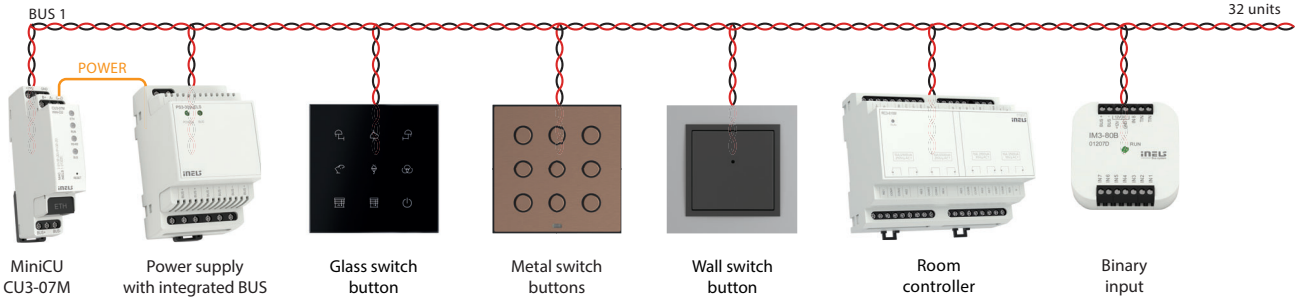
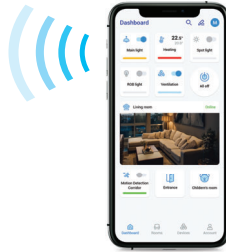

RADIO 868 Mhz

eLAN-RF-103

## Central units



**CU3-07M**  
Central unit  
with 1x BUS,  
max. 32 Elements



**CU3-08M**  
Central unit  
with 2x BUS,  
max. 64 Elements



**CU3-09M/DALI**  
Central unit  
with 1 BUS, 1x DALI,  
max. 32 Elements



**CU3-10M**  
Central unit  
with 1x BUS,  
1x MODBUS

## Detectors | sensors



**MCD3-01**  
Ultra slim microwave  
motion detector - ceiling  
mount



**PMS3-01**  
Ultra slim PIR motion  
detector - ceiling mount



**DLS3-1**  
Light intensity sensor



**ADC3-60M**  
Analog-to-digital converter,  
6 inputs



**DAC3-04M**  
Digital to analog converter,  
4 outputs

## Converters

## Input units



**IM3-40B**  
Binary input unit,  
4 inputs



**IM3-80B**  
Binary input unit,  
8 inputs



**IM3-140M**  
Binary input unit,  
14 inputs



**TI3-40B**  
Temperature input,  
4 inputs



**TI3-60M**  
Temperature input,  
6 inputs

## Switching actuators



**SA3-01B, SA3-02B**  
Switching actuator,  
1 channel and 2  
channels



**SA3-04M**  
Switching  
actuator,  
4 channels



**SA3-06M**  
Switching  
actuator,  
6 channels



**SA3-014M**  
Switching actuator,  
14 channels



**SA3-014M/E**  
Switching actuator,  
14 channels (without  
manual control  
buttons and RE  
status LED)



**SA3-022M**  
Switching actuator,  
22 channels



**EA3-022M**  
Switching actuator  
without controls and  
indicators,  
22 channels

## System units



**PS3-30/iNELS**  
Power supply  
with integrated BUS  
separator



**BPS3-01M,  
BPS3-02M**  
Bus separator  
from power supply



**PSM3-30/iNELS**  
Power supply  
for iNELS BUS



**PSM3-60/iNELS**  
Power supply  
for iNELS BUS



**PSM3-100/iNELS**  
Power supply  
for iNELS BUS

## Lighting control



**DA3-22M**  
Universal dimming  
actuator,  
2 channels



**DA3-66M**  
Dimming actuator,  
6 channels



**DA3-03M/RGBW**  
Dimming actuator  
for RGBW strips

## Shutter actuators



**JA3-014M**  
Shutter actuator,  
14 channels



**JA3-014M/E**  
Shutter actuator,  
14 channels (without  
manual control  
buttons and RE  
status LED)

## Combined units

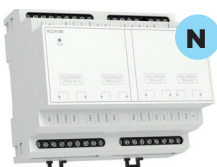

**RC3-610M/DALI**  
Room controller  
with DALI dimmer



**FA3-612M**  
Fancoil controller

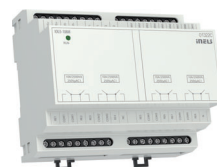

**IOU3-108M**  
Universal unit with  
10 inputs and 8 outputs

### Legend:



NEW

Wall controllers

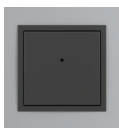

**WSB3-20,  
WSB3-20H**  
Wall switch button,  
2 buttons

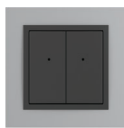

**WSB3-40,  
WSB3-40H**  
Wall switch button,  
4 buttons

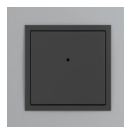

**WMR3-21**  
Wall card reader

Glass controllers

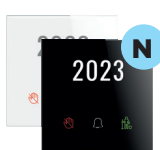

**GCR3-30**  
sharp  
Glass card reader



**GCR3-230**  
round  
Glass card reader



**GSB3-40**  
sharp  
Glass switch buttons



**GSB3-60**  
sharp  
Glass switch buttons

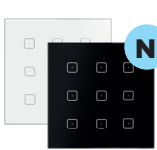

**GSB3-90**  
sharp  
Glass switch buttons



**GSB3-240**  
round  
Glass switch buttons



**GSB3-260**  
round  
Glass switch buttons



**GSB3-290**  
round  
Glass switch buttons

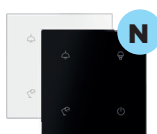

**GSB3-40/S**  
sharp  
Glass switch buttons with symbols

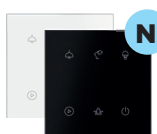

**GSB3-60/S**  
sharp  
Glass switch buttons with symbols

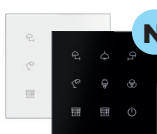

**GSB3-90/S**  
sharp  
Glass switch buttons with symbols



**GSB3-240/S**  
round  
Glass switch buttons with symbols



**GSB3-260/S**  
round  
Glass switch buttons with symbols



**GSB3-290/S**  
round  
Glass switch buttons with symbols

Glass switch buttons with symbols

Metal controllers

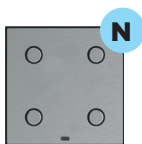

**MSB3-40/SS**  
Brushed silver  
Metal switch buttons

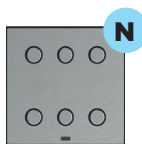

**MSB3-60/SS**  
Brushed silver  
Metal switch buttons

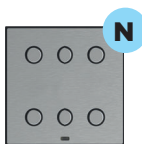

**MSB3-90/SS**  
Brushed silver  
Metal switch buttons

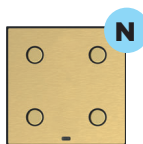

**MSB3-40/GG**  
Satin brass  
Metal switch buttons

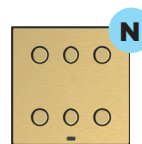

**MSB3-60/GG**  
Satin brass  
Metal switch buttons

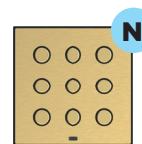

**MSB3-90/GG**  
Satin brass  
Metal switch buttons

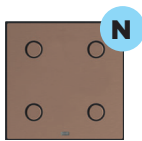

**MSB3-40/CC**  
Antique copper  
Metal switch buttons

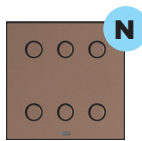

**MSB3-60/CC**  
Antique copper  
Metal switch buttons

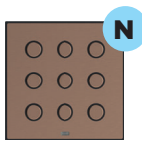

**MSB3-90/CC**  
Antique copper  
Metal switch buttons

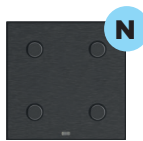

**MSB3-40/BB**  
Graphite black  
Metal switch buttons

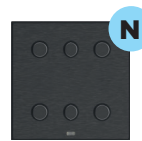

**MSB3-60/BB**  
Graphite black  
Metal switch buttons

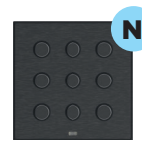

**MSB3-90/BB**  
Graphite black  
Metal switch buttons

Metal switch buttons

Thermo-regulators



**IDRT3-1**  
Digital room  
thermo-regulator



**GRT3-70**  
sharp  
Glass room  
thermo-regulator



**GRT3-270**  
round  
Glass room  
thermo-regulator



**GRT3-100**  
Glass room  
thermo-regulator

Touch units



**EST4**  
4" room  
controller panel



**EST8**  
8" touch  
control panel



**EST10**  
10" touch  
control panel

Integration

Multimedia



**iNELS Bridge**  
Third-party integration  
gateway



**Connection Server II.**  
Third-party integration server



**LARA Radio**  
Player Internet radio

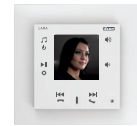

**LARA Intercom**  
Multifunction communication  
equipment

iNELS app

Accessories



New application for controlling all compatible  
elements from the iNELS portfolio.



**TELVA-2 230V,**  
**TELVA-2 24V**  
Thermodrive



**AN-I, AN-E**  
Internal antenna  
External antenna



**TC, TZ, Pt100**  
Thermo sensors

Legend:





EAN code  
CU3-07M: 8595188180108  
Order Code: 8010

## Technical parameters CU3-07M

### Indication LED STATUS

Green LED RUN:	Flashing-communication with BUS, On-no communication
Red LED ERR:	Flashing - no project, ON - unit STOP

### Communication

<b>iNELS BUS</b>	
Indication (LED BUS):	green - unit status indication red - BUS fault indication
Maximum number of units:	max. 32 units to one BUS line
Maximum cable length:	max. 300 m (depends on power loss)
<b>Ethernet</b>	
Connector:	RJ45
Communication speed:	100 Mbps
Indication of the Ethernet (LED ETH):	green - Ethernet communication yellow - Ethernet speed 100 Mbps
The default IP address:	192.168.1.1

### Button RESET

Restart:	short press
Reset (Factory Reset):	press the button to apply power, release the button 10 s after power is applied

### Power supply

Supply voltage/tolerance:	27 V DC, -20/+10 %
Rated current:	50 mA (at 27 V DC)

### Operating conditions

Operating temperature:	-20 to +55 °C
Storage temperature:	-25 to +70 °C
Humidity:	max. 80%
Protection degree:	IP20 device, IP40 with cover in the switchboard
Oversoltage category:	II.
Pollution degree:	2
Operating position:	any
Installation:	to the switching board on the EN 60715 DIN rail
Design:	1-MODULE
Terminal:	max. 2.5 mm <sup>2</sup>

### Dimensions and weight

Dimensions:	94 x 17.6 x 64 mm
Weight:	72 g
Standards:	EN 63044-1, EN 62368-1

- CU3-07M is one of the basic system control units of iNELS BUS installations.
- The unit can work independently, as an autonomous project, or it can be controlled by the central software as part of a larger project.
- The unit is equipped with one BUS to which it is possible to connect up to 32 elements from the iNELS BUS portfolio.
- The current load of one line is max, 1 A, BPS3-01M with 3 A can be used incase of connected device with more than 1 A.
- The RJ45 100 Mbps Ethernet connector is used for direct communication with the cloud for mobile app control or for communication with the superior unit within the iNELS IP topology.
- Configuration takes place in the iNELS3 Designer & Manager software (iDM3).
- Through iDM3 it is possible to update the firmware of central units and bus connected peripheral units.
- The central unit is implemented with MQTT protocol for 3rd party communication.
- The unit is powered by 27 V DC from iNELS power supply.
- System units CU3-07M in 1-MODULE design are designed for mounting into a switchboard on DIN rail EN60715.

## Connection

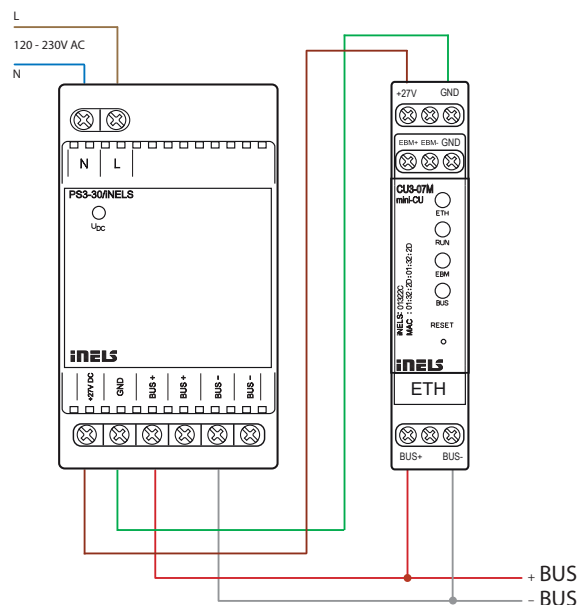

max. 32 units per BUS; max. 1A (PS3-30 / iNELS) per BUS



EAN code  
CU3-08M: 8595188184403  
Order Code: 9163

Technical parameters		CU3-08M
<b>Indication LED STATUS</b>		
Green - RUN:	The main program runs	
Red- ERR:	The main program stalled	
<b>Communication</b>		
System bus BUS1/BUS2		
Status indication (LED BUS):	green - indication of the operating status of the bus red - error indication on the bus	
Maximum number of units:	2x32 Units	
Maximum line length:	max. 300 m (depends on power loss)	
<b>Ethernet</b>		
Connector:	RJ45	
Communication speed:	100 Mbps	
Ethernet status indication (LED ETH):	green - Ethernet communication yellow - Ethernet speed 100 Mbps	
Default IP address:	192.168.1.1	
<b>RESET button</b>		
Restart:	Short press	
Reset (factory reset settings):	press the button to bring power on, button release 10 s after power is supplied	
<b>Power</b>		
<b>BUS1</b>		
Supply voltage/tolerance:	27 V DC, -20/+10 %	
Rated current:	50 mA (at 27 V DC)	
<b>BUS2</b>		
Supply voltage/tolerance:	27 V DC, -20/+10 %	
Rated current:	50 mA (at 27 V DC)	
<b>Operating conditions</b>		
Working temperature:	-20 to +55 °C	
Storage temperature:	-25 to +70 °C	
Air humidity:	max. 80%	
Degree of protection:	IP20 device, IP40 with cover in the control cabinet	
Surge category:	II.	
Degree of pollution:	2	
Working position:	any	
Installation:	to the control cabinet for DIN rail EN 60715	
Design:	1-MODULE	
Terminal plate:	max. 2.5 mm <sup>2</sup>	
<b>Dimensions and weight</b>		
Dimensions:	94 x 17.6 x 64 mm	
Weight:	72 g	
Standards:	EN 63044-1, EN 62368-1	

- CU3-08M is one of the basic system control of iNELS BUS installations.
- The unit can work independently, as an autonomous project, or it can be controlled by the central software as part of a larger Project.
- The units is equipped with two BUS, to which it is possible to connect a total of up to 64 elements (2x32) from the iNELS BUS portfolio.
- The current load of one line is max. 1 A. BPS3-01M with 3 A can be used in case of connected device with more than 1 A.
- The RJ45 100 Mbps Ethernet connector is used for direct communication with the cloud for mobile app control or for communication with the superior unit within the iNELS IP topology.
- Configuration takes place in the iNELS3 Designer & Manager software (iDM3). Through iDM3 it is possible to update the firmware of central units and bus connected peripheral units.
- The central unit is implemented with MQTT protocol for 3rd party communication.
- The units is powered by 27 V DC from iNELS power supply. BUS1 can power the central unit.
- System units CU3-08M in 1-MODULE design are designed for mounting into a switchboard on DIN rail EN60715.

Connection

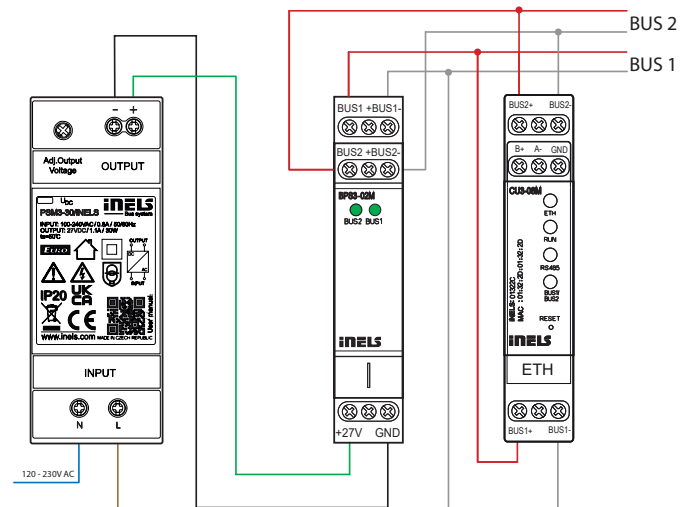



EAN code  
CU3-09M/DALI: 8595188184656  
Order Code: 8465

## Technical parameters CU3-09M/DALI

### Indication LED STATUS

Green - RUN:	The main program runs
Red - ERR:	The main program stalled

### Communication

<b>System BUS</b>	
Maximum number of units:	max. 32 Units
Status indication (LED BUS):	green: BUS Operating Status red: error indication on the bus
Bus power supply:	external DALI power supply must be connected
<b>Ethernet</b>	
Connector:	RJ45
Communication speed:	100 Mbps
Ethernet status indication (LED ETH):	green - Ethernet communication yellow - speed Ethernet 100 Mbps
Default IP address:	192.168.1.1

### RESET button

Restart:	short press
Reset (return to factory settings):	press the button to bring power on, button release 10 s after power is supplied

### Power

Supply voltage/tolerance:	27 V DC, -20/+10 %
Rated current:	50 mA (at 27 V DC)

### Operating conditions

Working temperature:	-20 to +55 °C
Storage temperature:	-25 to +70 °C
Air humidity:	max. 80%
Degree of protection:	IP20 device, IP40 with cover in the control cabinet
Surge Category:	II.
Degree of pollution:	2
Working position:	any
Installation:	to the control cabinet for DIN rail EN 60715
Design:	1-MODULE
Terminal plate:	max. 2.5 mm <sup>2</sup>

### Dimensions and weight

Dimensions:	94 x 17.6 x 64 mm
Weight:	72 g
Standards:	EN 63044-1, EN 62368-1

- CU3-09M is one of the basic system control units of iNELS BUS installations.
- The unit can work independently, as an autonomous project, or it can be controlled by the central software as part of a larger project.
- The unit is equipped with one BUS to switch it is possible to connect up to 32 elements from the iNELS BUS portfolio.
- The current load of one line is max. 1 A. BPS3-01M with 3 A can be used in case of connected device with more than 1 A.
- The CU3-09M/DALI system unit is equipped with one DALI bus.
- The DALI system bus allow control of up to 64 independent DALI ballast addresses for luminaires.
- Addressing of DALI can be done via the iDM3 software.
- The RJ45 100 Mbps Ethernet connector is used for direct communication with the cloud for mobile app control or for communication with the superior unit within the iNELS IP topology.
- Configuration takes place in the iNELS3 Designer & Manager software (iDM3).
- Through iDM3 it is possible to update the firmware of central units and bus connected peripheral units.
- The central unit is implemented with MQTT protocol for 3rd party communication.
- The unit is powered by 27 V DC from iNELS power supply. BUS1 can power the central unit.
- System units CU3-09M/DALI in 1-MODULE design are designed for mounting into a switchboard on DIN rail EN60715.

## Connection

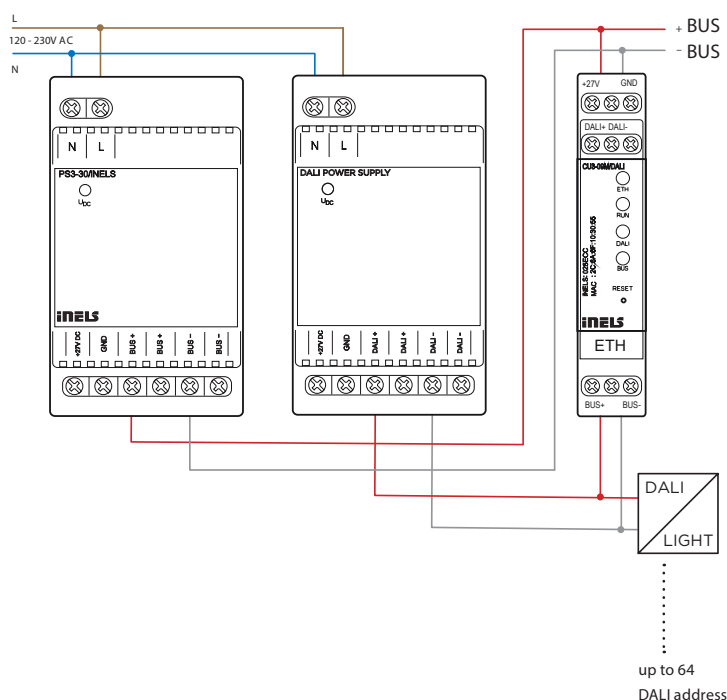





EAN code  
CU3-10M: 8595188185219  
Order Code: 8521

Technical parameters		CU3-10M
<b>Indication LED STATUS</b>		
Green - RUN:	Flashing-communication with BUS, On-no communication	
Red- ERR:	Flashing - no project, ON - unit STOP	
<b>Communication</b>		
System bus BUS1		
Status indication (LED BUS):	green - unit status indication red - BUS fault indication	
Maximum number of units:	max. 32 units to one BUS line	
Maximum line length:	max. 300 m (depends on power loss)	
<b>Ethernet</b>		
Connector:	RJ45	
Communication speed:	100 Mbps	
Ethernet status indication (LED ETH):	green - Ethernet communication yellow - Ethernet speed 100 Mbps	
Default IP address:	192.168.1.1	
<b>RESET button</b>		
Restart:	short press	
Reset (factory reset settings):	press the button to apply power, release the button 10 s after power is applied	
<b>Power</b>		
<b>BUS</b>		
Supply voltage/tolerance:	27 V DC, -20/+10 %	
Rated current:	50 mA (at 27 V DC)	
<b>Operating conditions</b>		
Working temperature:	-20 to +55 °C	
Storage temperature:	-25 to +70 °C	
Air humidity:	max. 80%	
Degree of protection:	IP20 device, IP40 with cover in the switchboard	
Surge category:	II.	
Degree of pollution:	2	
Working position:	any	
Installation:	to the switching board on the EN 60715 DIN rail	
Design:	1-MODULE	
Terminal plate:	max. 2.5 mm <sup>2</sup>	
<b>Dimensions and weight</b>		
Dimensions:	94 x 17,6 x 64 mm	
Weight:	72 g	
Standards:	EN 63044-1, EN 62368-1	

- CU3-10M is one of the basic system control units of iNELS BUS installations.
- The unit can work independently, as an autonomous project, or it can be controlled by the central software as part of a larger project.
- The unit is equipped with one BUS to switch it is possible to connect up to 32 elements from the iNELS BUS portfolio.
- The current load of one line is max. 1 A. BPS3-01M with 3 A can be used in case of connected device with more than 1 A.
- The CU3-10M system unit is equipped with one Modbus system bus. The Modbus system bus allows control of modbus thermostat and Air condition units (RS-485).
- The RJ45 100 Mbps Ethernet connector is used direct communication with the cloud for mobile app control or for communication with the superior unit within the iNELS IP topology.
- Configuration takes place in the iNELS3 Designer & Manager software (iDM3). Through iDM3 it is possible to update the firmware of central units and bus connected peripheral units.
- The central unit is implemented with MQTT protocol for 3rd party communication.
- The unit is powered by 27 V DC from iNELS power supply.
- System units CU3-10M in 1-MODULE design are designed for mounting into a switchboard on DIN rail EN60715.

Connection

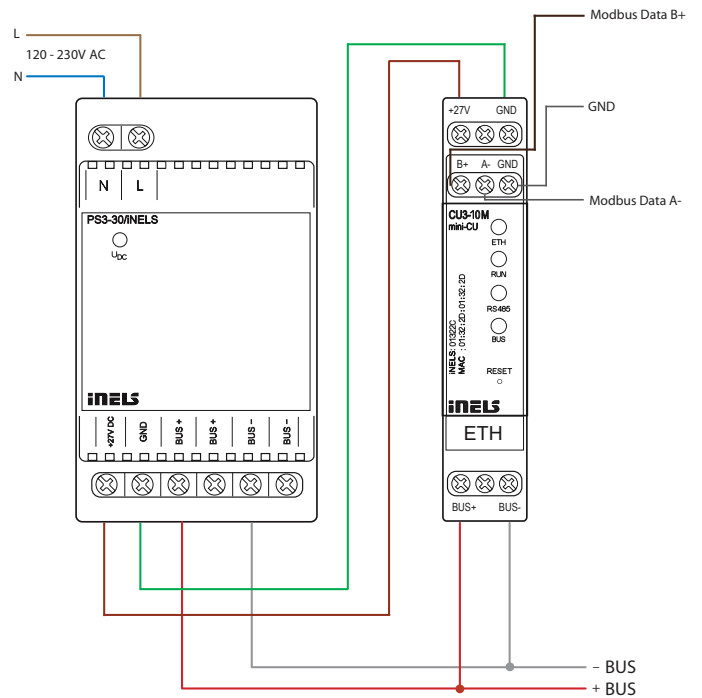



EAN code  
PS3-30/iNELS: 8595188180115  
Order Code: 8011

## Technical parameters PS3-30/iNELS

### Input AC

Supply voltage:	100 - 250 V AC/50 - 60 Hz
Power dissipation:	max. 6.5 W
No-load power (apparent/active):	max. 10 VA/1.5 W
Power consumption at max. Load (apparent/active):	max. 54 VA/33 W
Protection:	T2A fuse inside the device

### Outputs

Output voltage:	27 V
Max. load capacity:	1 A
Overall resource efficiency:	> 82 %
Time delay after Connection to AC network:	max. 5 s

### Indication LED

Green LED POWER:	Supply voltage indication
Green LED BUS:	indication of the operating status of the bus

### Operating conditions

Electrical power INPUT AC - OUTPUT BUS:	4 kV
Connection terminals:	Ordinal
Cross-section of connecting wires (mm <sup>2</sup> ):	max. 1 x 2.5, max. 2 x 1.5 (With core max. 1 x 1.5)
Working temperature:	-20 °C to +55 °C
Storage temperature:	-30 °C to +70 °C
Working air humidity:	20 to 90 % RH
Degree of protection:	IP20 device, IP40 with cover in the control cabinet
Surge category:	III.
Degree of pollution:	2
Working position:	any, optimally vertical
Installation:	to the control cabinet for DIN rail EN 60715
Design:	3-MODULE
Dimensions:	90 x 52 x 65 mm
Weight:	160 g
Related standards:	general: EN61204, safety: EN61204-7, EMC: EN61204-3

- PS3-30/iNELS is a switched stabilized power supply with a total power of 30 W.
- PS3-30/iNELS is used to power central units and external masters within the iNELS bus wiring.
- PS3-30/iNELS it is equipped with electronic protection against short circuit, overvoltage, power and temperature overload.
- The power supply includes an internally integrated BPS3-01M bus isolator to power one branch of the BUS, from which the iNELS peripheral units are further powered.
- PS3-30/iNELS 3-MODULE is designed for mounting in a switchboard on DIN rail EN60715.

## Connection

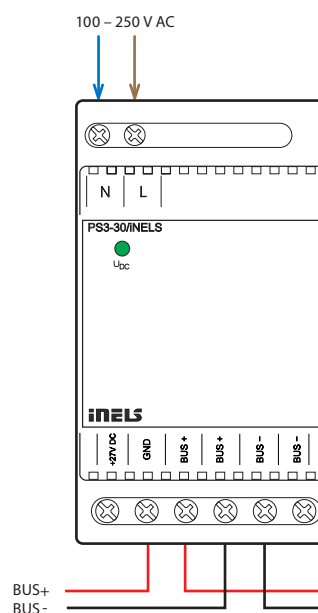



EAN code  
 BPS3-01M: 8595188132442  
 BPS3-02M: 8595188132435

Order Code:  
 BPS3-01M: 9164  
 BPS3-02M: 9165

Technical parameters	BPS3-01M	BPS3-02M
<b>Outputs</b>		
Maximum load capacity:	3 A	2x 1 A
<b>Communication</b>		
Installation bus:	1x BUS	2x BUS
<b>Power</b>		
Supply voltage/tolerance:	27 V DC, -20/+10 %	
Power dissipation:	max. 0.5 W	
Rated current without		
Output load:	max. 8 mA	max. 15 mA
Voltage status indication on		
Terminals:	1x green LED	2x green LED
<b>Connection</b>		
Terminal plate:	max. 2.5 mm <sup>2</sup> /1.5 mm <sup>2</sup> with core	
<b>Operating conditions</b>		
Working temperature:	-20 to +55 °C	
Storage temperature:	-30 to +70 °C	
Cover:	IP20 device, IP40 with cover in the control cabinet	
Surge category:	II.	
Degree of pollution:	2	
Working position:	any	
Installation:	to the control cabinet for DIN rail EN 60715	
Design:	1-MODULE	
<b>Dimensions and weight</b>		
Dimensions:	90 x 17.6 x 64 mm	
Weight:	70 g	85 g
Standards:	EN 63044-1	

- The BPS3-01M and BPS3-02M units are used for impedance separation of the BUS from the supply voltage source.
- A BPS3-01M or BPS3-02M bus isolator is required for each CU3-XXM central unit.
- BPS3-01M allows the connection of one BUS branch with a load of max. 3 A.
- BPS3-02M allows the connection of two BUS branches with a load of max. 1 A for each branch.
- The outputs are equipped with overcurrent and surge protection.
- Indication of the output voltage of the BUS outputs by LEDs.
- BPS3-01M, BPS3-02M in 1-MODULE design are designed for mounting in a switchboard on DIN rail EN60715.

Connection

BPS3-01M + CU3-07M

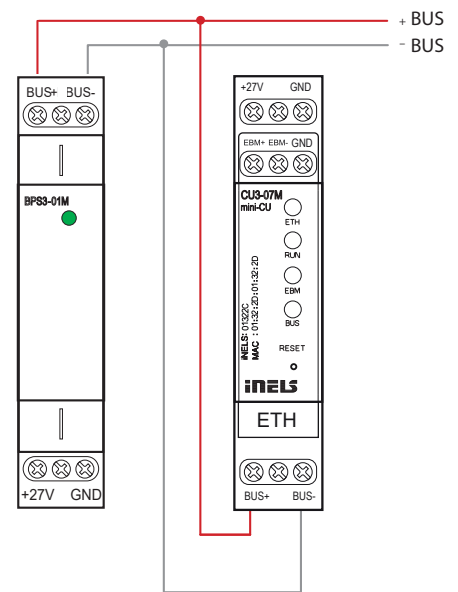

BPS3-02M + CU3-08M

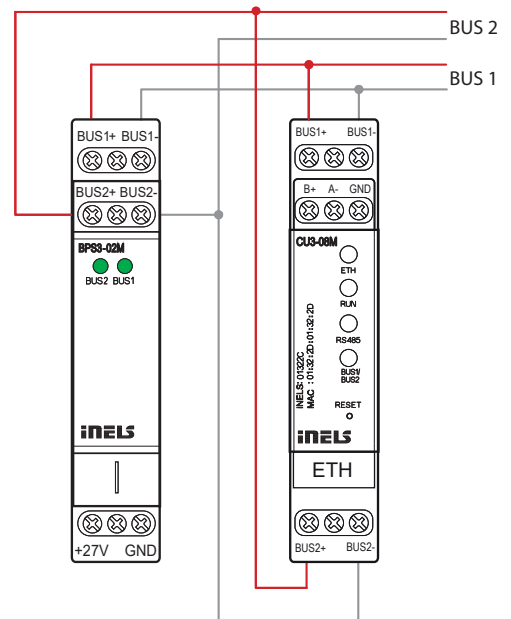

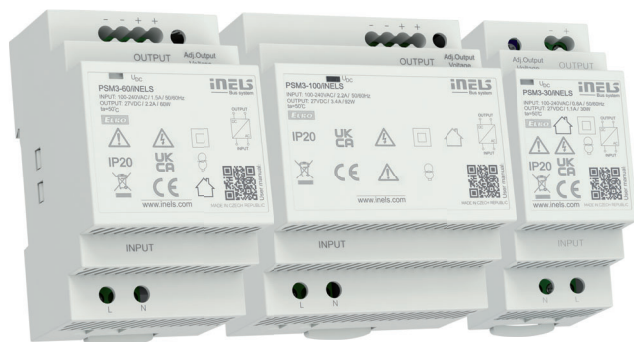

- Used to supply central units and external master within intelligent electroinstallation iNELS.
- Through BUS separators from the supply voltage BPS3-01M and BPS3-02M, it supplies BUS lines from which iNELS peripheral units are also powered.
- Rated output voltage 27V DC with the possibility of regulation.
- High efficiency of up to 90%.
- Low ripple & noise.
- Protection: Overload, Over voltage and Short circuit.
- Continuously adjustable output voltage to adapt to the specific application, e.g. the need to compensate for the voltage drop caused by the length of the line.

EAN code: PSM3-100/iNELS - 8595188184786  
 PSM3-60/iNELS - 8595188184779  
 PSM3-30/iNELS - 8595188184762

Order Code: PSM3-100/iNELS - 8478  
 PSM3-60/iNELS - 8477  
 PSM3-30/iNELS - 8476

Technical parameters	PSM3-30/iNELS	PSM3-60/iNELS	PSM3-100/iNELS
<b>Input</b>			
Voltage range:	AC 100 - 240 V (50-60 Hz)		
Tolerance:	± 10%		
Efficiency:	89%	90%	90%
Burden without load (max.):	0.4W / 8VA	0.5W / 6.5VA	0.1W / 12VA
Burden with full load (max.):	33W / 60VA	70W / 111VA	105W / 160VA
Inrush current:*	max. 25A at 115V AC/60Hz max. 45A at 240V AC/50Hz	max. 30A at 115V AC/60Hz max. 60A at 240V AC/50Hz	max. 35A at 115V AC/60Hz max. 70A at 240V AC/50Hz
<b>Output</b>			
Rated voltage:	27V DC	27V DC	27V DC
Vol. setting range:	21.5 - 28.5V	20.5 - 29V	24.5 - 28V
Rated current:	1.1A	2.2A	3.4A
Rated power:	30W	60W	92W
Ripple & Noise:	150mV	150mV	150mV
Output indication:	blue LED	green LED	blue LED
Tolerance of output voltage:	5 %		
Overload protection:	from 130% - 200% rated output power		
Overvoltage protection:	from 110 % - 145% rated output power		
Overcurrent protection:	from 110% - 180% rated output power		
Short circuit protection:	temporarily disconnecting the output		
<b>Other information</b>			
Operating temperature:	-20 to +50°C		
Operating humidity:	20% ~ 90% non-condensing		
Storage temperature:	-40 to +80°C		
Dielectric strength:	3kV AC		
Isolation resistance:	100M Ω / 500V DC / 25°C / 70% RH		
Overvoltage category:	III.		
Pollution degree:	2		
Max. cable size:	max. 1x 2.5 mm <sup>2</sup> , max. 2x 1.5 mm <sup>2</sup> solid wire / with sleeve max. 1x 2,5 mm <sup>2</sup>		
Terminal torque:			
Input terminals:	0.3 Nm		
Output terminals:	0.5 Nm		
Protection degree:	IP20		
MTBF:	200 000 hours minimum, full load at 25°C ambient temperature		
Mounting:	DIN rail EN 60715		
Dimensions:	90 x 35 x 58 mm	90 x 52.5 x 58 mm	90 x 70 x 58 mm
Weight:	120 g	190 g	270 g
Standards:	general: EN61204, safety: EN61204-7, EMC: EN61204-3		

\* The stated values are valid for the full load from the source

Description

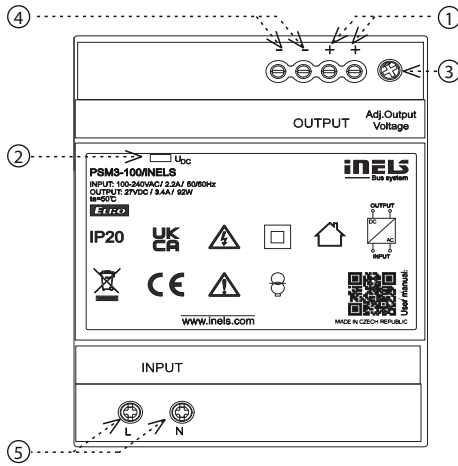
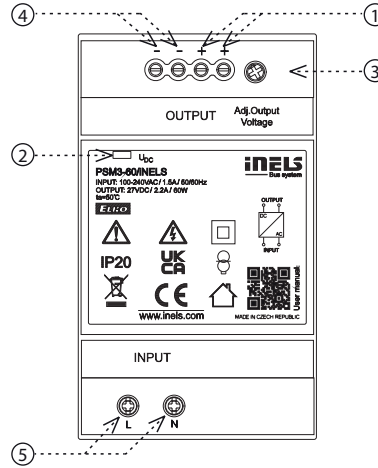
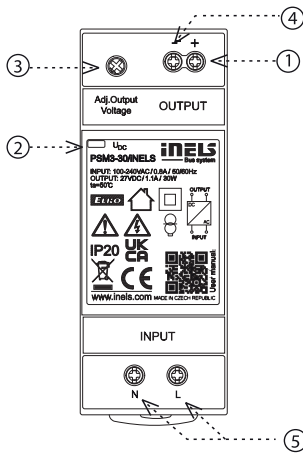

1. Output voltage terminals ⊕
2. Output voltage indication
3. Adjusting the output voltage
4. Output voltage terminals ⊖
5. Supply terminals

Connection

PSM3-30/iNELS

DC 27 V / 1.1 A

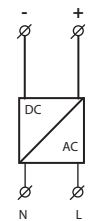

AC 100 - 240 V  
50 Hz / 60 Hz

PSM3-60/iNELS

DC 27 V / 2.2 A

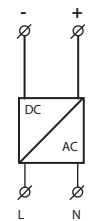

AC 100 - 240 V  
50 Hz / 60 Hz

PSM3-100/iNELS

DC 27 V / 3.4 A

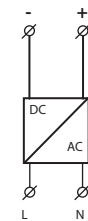

AC 100 - 240 V  
50 Hz / 60 Hz

Power supplies PSxM are overcurrent protection devices, because it turns power supplies off, if the output current exceeds more than 30 % of the rated output of the power supply. Therefore, these units are not intended to supply e.g. halogen lamps, because the starting / inrush current (in the cold state) is approximately ten times the amount of the steady-state operating current. So these power supplies cannot turn on such lamps.



EAN code  
MCD3-01: 8595188191234  
Order Code: 9123

### Technical parameters MCD3-01

#### Inputs

HF system:	5.8 GHz CW radar, ISM band
Detection angle:	360°
Reach:	2-10 m (radius.), adjustable
Time setting:	in iDM software
Recommended installation height:	2.5 - 3 m
Changing the sensitivity:	yes (in hardware)
Light metering:	yes (in hardware)

#### Communication

Terminals:	0.3 - 0.8 mm <sup>2</sup>
Interface:	installation iNELS BUS

#### Power supply

From iNELS BUS:	27 V DC, -20/+10 %, 20 mA
-----------------	---------------------------

#### Operating conditions

Work temperature:	-10 to 40 °C
Operation position:	free
Installation:	ceiling/surface

#### Dimension and weight

Dimension:	115 x 24 mm
Standards:	EN 302372, EN 301489, EN 63044-1

#### Connection

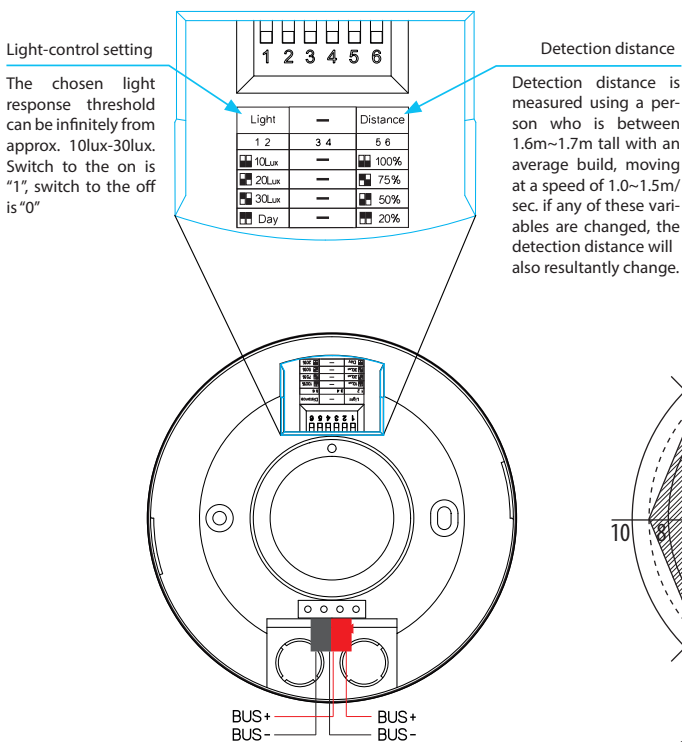

- The MCD3-01 is a highly versatile and compact motion sensor designed for ceiling or surface mounting applications. With its ultra-slim design, the MCD3-01 seamlessly integrates into various environments, providing reliable and efficient motion detection capabilities.
- The sensor is powered by a 27 VDC power source, specifically the iNELS BUS system, ensuring stable and efficient operation.
- The MCD3-01 utilizes a 5.8 GHz continuous wave (CW) radar system operating in the ISM band, offering precise and reliable motion detection.
- The sensor provides a wide 360-degree detection angle, ensuring comprehensive coverage of the monitored area.
- The sensor's reach is adjustable, allowing the user to set the detection range. The reach can be configured within the range of 2 to 10 meters in radius, providing flexibility for different applications.
- The MCD3-01 features a software setting for adjusting time settings. The time setting can be configured, allowing customization of the sensor's activation duration.
- Designed to operate effectively in various environmental conditions, the sensor has a wide working temperature range of -10°C to +40°C, ensuring reliable performance in different settings.
- The MCD3-01 can be seamlessly integrated and combined with other iNELS units using the iDM3 software. This allows for the implementation of additional logics and functions, enabling automation and customized control scenarios based on specific requirements.
- The MCD3-01 features a compact form factor with dimensions of 115 x 24 mm, facilitating easy installation and integration into different ceiling or surface mounting applications.

#### Another view

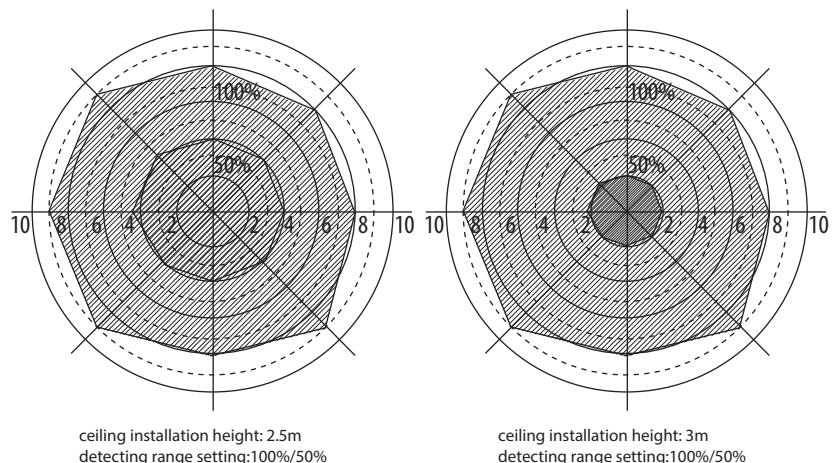
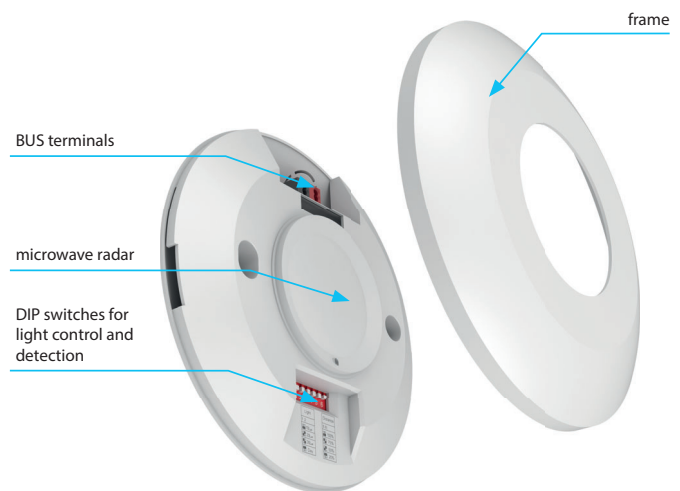



EAN code  
PMS3-01: 8595188191357  
Order Code: 9135

Technical parameters		PMS3-01
<b>Inputs</b>		
Detection angle:	360°	
Time setting:	in iDM software	
Recommended installation height:	2.5 - 3.5 m	
Luminance control:	yes (in hardware)	
<b>Communication</b>		
Terminals:	0.3 - 0.8 mm <sup>2</sup>	
Interface:	installation iNELS BUS	
<b>Power supply</b>		
From iNELS BUS:	27 V DC, -20/+10 %, 20 mA	
<b>Operating conditions</b>		
Work temperature:	-10 to 40 °C	
Operation position:	free	
Installation:	ceiling/surface	
<b>Dimension and weight</b>		
Dimension:	115 x 24 mm	
Standards:	EN 63044-1	

Connection

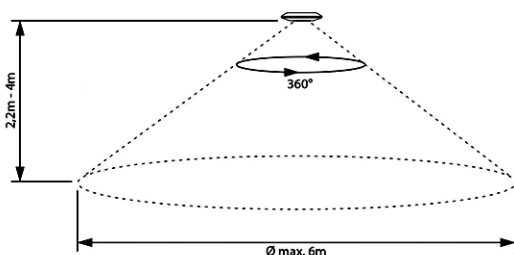
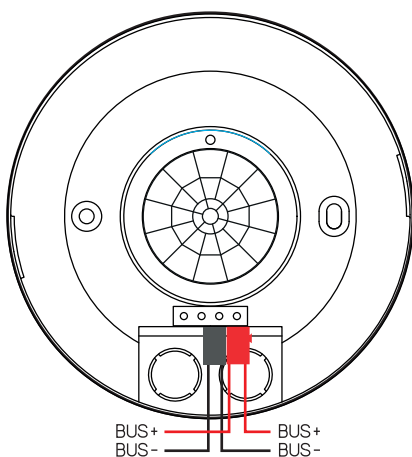

- The PMS3-01 is a highly versatile and compact motion sensor designed for ceiling or surface mounting applications. With its ultra-slim design, the PMS3-01 seamlessly integrates into various environments, providing reliable and efficient motion detection capabilities.
- The sensor is powered by a 27 VDC power source, specifically the iNELS BUS system, ensuring stable and efficient operation.
- The PMS3-01 utilizes an infrared for precise and reliable motion detection.
- The sensor provides a wide 360-degree detection angle, ensuring comprehensive coverage of the monitored area.
- The sensor's reach is upto 6m max, allowing the user to install the unit at a height of 2.5 m-3.5 m, providing flexibility for different applications.
- The PMS3-01 features a software setting for adjusting time settings. The time setting can be configured, allowing customization of the sensor's activation duration.
- Designed to operate effectively in various environmental conditions, the sensor has a wide working temperature range of -10°C to +40°C, ensuring reliable performance in different settings.
- The PMS3-01 can be seamlessly integrated and combined with other iNELS units using the iDM3 software. This allows for the implementation of additional logics and functions, enabling automation and customized control scenarios based on specific requirements.
- The PMS3-01 features a compact form factor with dimensions of 115 x 24 mm, facilitating easy installation and integration into different ceiling or surface mounting applications.

Another view

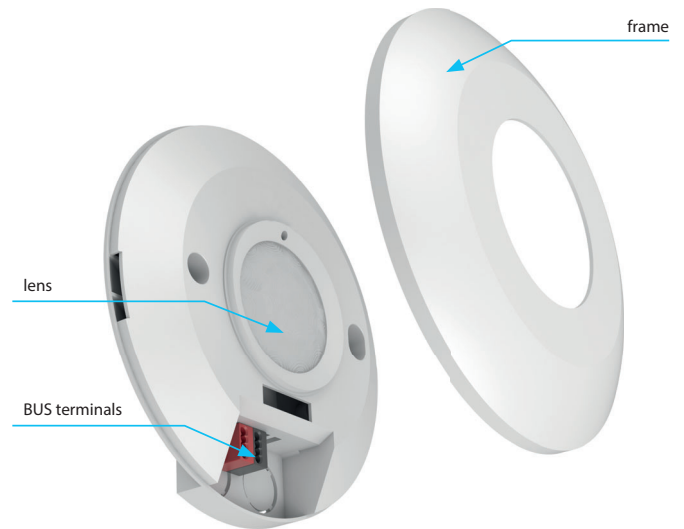



EAN code  
DLS3-1: 8595188157506  
Order Code: 5750

Technical parameters		DLS3-1
<b>Inputs</b>		
Range of measurement of lighting:	1 - 100 000 lx	
Detection angle:	40 °	
<b>Outputs</b>		
Indication red LED:	identification DALI MASTER/setting indication	
Indication green LED RUN:	communications/unit status	
<b>Communication</b>		
Interface:	installation iNELS BUS, DALI	
<b>Power supply</b>		
From iNELS BUS:	27 V DC, -20/+10 %	
Rated current:	12 mA (27 V DC)	
From DALI BUS:	16 V (max. 23 V)	
Rated current:	20 mA (16 V DC)	
Dissipated power:	max. 0.5 W	
<b>Connection</b>		
Terminals:	max. 1x2.5, max. 2x1.5/with sleeve max. 1x2.5 mm <sup>2</sup>	
<b>Operating conditions</b>		
Operating temperature:	-30 to +60 °C	
Storing temperature:	-30 to +70 °C	
Protection degree:	IP65	
Operating position:	vertical	
<b>Dimension and weight</b>		
Dimension:	96 x 62 x 34 mm	
Weight:	100 g	
Standards:	EN 63044-1	

For proper function of the detector it is necessary to eliminate all sources of light interference in the sensing area.

- The luminescence sensor DLS3-1 is for sensing the current luminescence at the point of installation of the unit.
- The DLS3-1 sensor is equipped with two communication interfaces:
  - iNELS BUS installation
  - DALI (a maximum 4 pcs of DMD3-1 or DLS3-1 units can be used on one DALI bus).
- Information about the current value of the light intensity can be used in tasks of maintaining constant luminescence. In space where it is possible, thanks to the contribution of natural light from the outside to adjust the artificial light, which can reduce energy consumption.
- Thanks to the DLS3-1 units cannot only be used in residential projects, but also in commercial projects, offices or manufacturing plants, warehouses.
- The DLS3-1 unit is recommended to be installed so that the luminescence sensor for sensing faces down and should not be exposed to direct radiation.
- Setting up a communication interface with DIP switches no. 1:
  - in the upper position determines the communication interface DALI
  - in the lower position determines the communication interface iNELS.
- The DLS3-1 detector is powered directly via the iNELS BUS installation (nominal 27 V DC) or DALI BUS (nominal 16 V DC).
- The unit can be configured via iNELS3 Designer & Manager software, which, amongst other things it is possible to:
  - Set the desired functions according to the detected illumination.
  - The sensing range is 1-100 000 lux.
- The DLS3-1 unit is supplied in IP65 and so can be installed in the outdoor environment.

## Connection

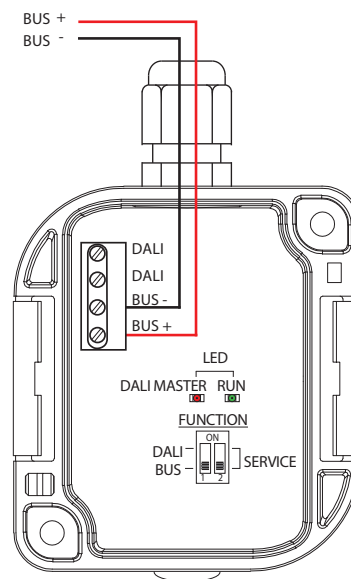







EAN code  
ADC3-60M: 8595188133012  
Order Code: 3301

## Technical parameters

## ADC3-60M

### Input

Analog inputs:	6x voltage, current or temperature input
Number of inputs:	6
Galv. separation from inner circuits:	no
Diagnostic:	indication (exceeding the range, interruption of a sensor or overload of Uref output) by the applicable red LED
Common terminal:	COM
Converter resolution:	14 bits
Input resistance	
- for voltage ranges:	approx. 150 k $\Omega$
- for current ranges:	100 $\Omega$
Types of inputs/measuring ranges*:	<b>Voltage (U):</b> 0 ÷ +10 V (U) ; 0 ÷ +2 V (U) <b>Current (I) :</b> 0 ÷ +20 mA (I) ; 4 ÷ +20 mA (I) <b>temperature:</b> input at ext. temperature sensor TC, TZ see accessories/according to used sensor from -40 °C to 125 °C

### Outputs of the Uref1 and Uref2 voltage

Voltage**/current of Uref1:	10 or 15 V DC/100 mA
Voltage**/current of Uref2:	10 V DC/20 mA

### Communication

Installation BUS:	BUS
Unit status indication:	green LED RUN

### Power supply

Supply voltage/tolerance:	27 V DC, -20/+10 %
Dissipated power:	max. 1 W
Rated current:	100 mA (at 27 V DC), from BUS

### Connection

Terminal:	max. 2.5 mm <sup>2</sup> /1.5 mm <sup>2</sup> with sleeve
-----------	---

### Operating conditions

Operating temperature:	-20 to +55 °C
Storing temperature:	-30 to +70 °C
Protection degree:	IP20 device, IP40 mounting in the switchboard
Overvoltage category:	II.
Pollution degree:	2
Operating position:	any
Installation:	into a switchboard rail to DIN EN 60715
Design:	3-MODULE

### Dimensions and weight

Dimensions:	90 x 52 x 65 mm
Weight:	112 g
Standards:	EN 63044-1

- ADC3-60M is an analog-to-digital converter and is equipped with 6 analog inputs.
- Analog inputs serve to connect temperature sensors or analog sensors that generates current or voltage signal.
- The analog inputs have a resolution of a 14-bit AD converter.
- The analog inputs have a common terminal COM.
- Analog inputs/outputs are configurable in iDM3 independently as voltage (U) or current (I) or temperature.
- We recommend Clima sensor as a meteo station. There are four types: five to eight outputs. The top series offers measuring of: rainfall, brightness, twilight, speed of wind, temperature and relative humidity.
- The red LEDs in the front panel indicate exceeding the range, interruption of a sensor or overload of Uref output.
- The temperature inputs at the top of the terminal are used to connect the following temperature sensors: TC, TZ.
- ADC3-60M in 3-MODULE version is designed for mounting into a switch-board, on a DIN rail EN60715.

## Connection

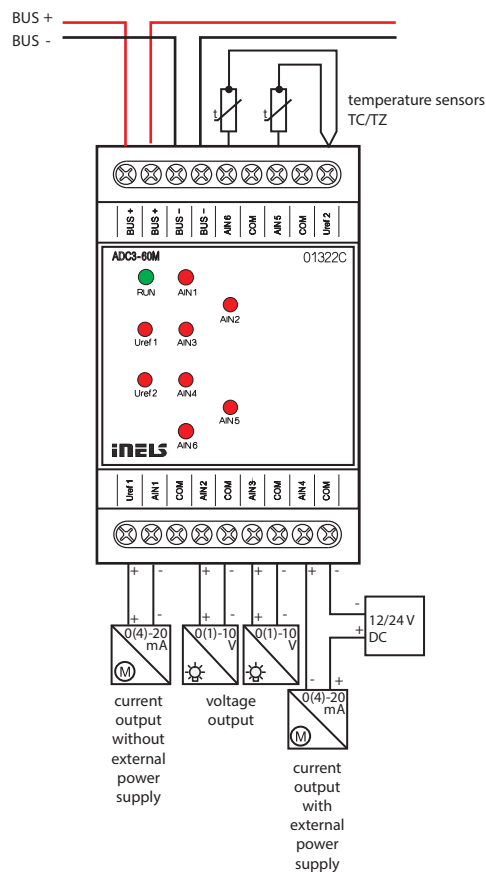

\* selectable for each input/output individually by configuration in the user program iDM3.  
Min. supply voltage 24 V DC must be respected when configuring 15 V DC and 100 mA consumption.

\*\* according to load Uref output.



EAN code  
DAC3-04M: 8595188132565  
Order Code: 3256

**Technical parameters** **DAC3-04M**

Input	
Temperature measuring:	yes, input for external temperature sensor TC/TZ
Range/accuracy of temp. measuring:	-20 to +120 °C; 0.5 °C from the range
Outputs	
Analog voltage output/rated current:	4x 0(1)-10 V/10 mA
Indication of output overload:	red LED OVERLOAD
Communication	
Installation BUS:	BUS
Status indication unit:	green LED RUN
Power supply	
Supply voltage/tolerance:	27 V DC, -20/+10 %
Dissipated power:	max. 1 W
Rated current:	50 mA (at 27 V DC), from BUS
Connection	
Terminal:	max. 2.5 mm <sup>2</sup> /1.5 mm <sup>2</sup> with sleeve
Operating conditions	
Air humidity:	max. 80 %
Operating temperature:	-20 to +55 °C
Storing temperature:	-30 to +70 °C
Protection degree:	IP20 device, IP40 mounting in the switchboard
Overvoltage category:	II.
Pollution degree:	2
Operating position:	any
Installation:	switchboard on DIN rail EN 60715
Design:	3-MODULE
Dimensions and weight	
Dimensions:	90 x 52 x 65 mm
Weight:	108 g
Standards:	EN 63044-1

- DAC3-04M is a converter from a digital signal to an analog voltage signal.
- The converter generates 4 analog voltage signals, which can be operated, according to type of controlled device, in a range 0-10 V or 1-10 V.
- This is used for regulating and controlling devices that may be controlled by this signal (dimnable ballasts of fluorescent lamps and other types of light sources - e.g. LED panels from the assortment of ELKO Lighting, dimming actuator for LED and RGB strips RFDA-73M/RGB, thermo drives, servo drives, elements for measuring and regulation and others).
- Range of output voltage is adjustable in iDM3.
- Converter is equipped with a temperature input for connecting a 2-wire external sensor TC/TZ (see accessories).
- DAC3-04M in 3-MODULE version is designed for mounting into a switchboard, on DIN rail EN60715.

**Connection**

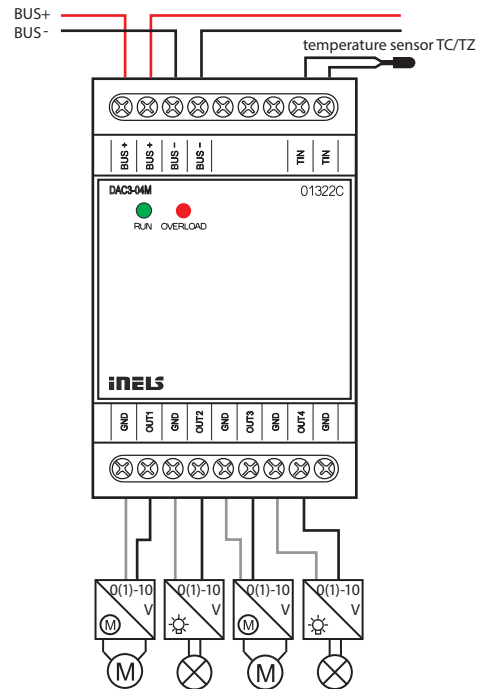

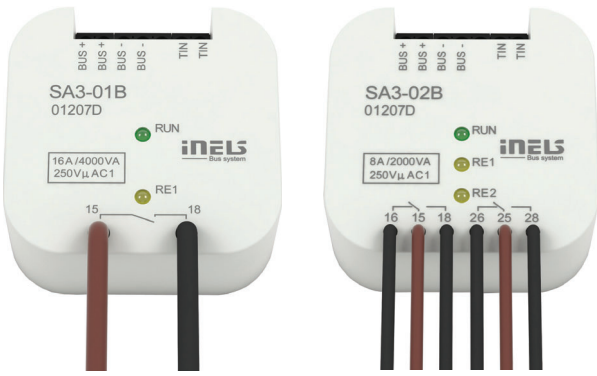

EAN code  
SA3-01B: 8595188132350  
SA3-02B: 8595188132367

Order Code:  
SA3-01B: 3235  
SA3-02B: 3236

Technical parameters	SA3-01B	SA3-02B
<b>Inputs</b>		
Temperature measuring:	Yes, input for external thermo sensor TC, TZ	
Scope and accuracy of tem.meas.:	-20 to +120°C; 0.5°C from the range	
<b>Outputs</b>		
Output:	1x NO 16 A	2x CO 8 A
Switching voltage:	250 V AC, 24 V DC	
Switched load:	4000 VA/AC1, 384 W/DC	2000 VA/AC1, 192 W/DC
Surge current:	30 A; max. 4 s. when repeating 10%	10 A
Output relays separated from all internal circuits:	reinforced insulation (Cat. II surges by EN 60664-1)	
Insulation voltage between relay outputs RE1-RE2:	x	basic isolation (Cat. II surges by EN 60664-1)
Minimal switching current:	100 mA/5 V	
Switching frequency/no load:	1200 min <sup>-1</sup>	300 min <sup>-1</sup>
Switching frequency/rated load:	6 min <sup>-1</sup>	15 min <sup>-1</sup>
Mechanical lifetime:	3x 10 <sup>7</sup>	1x 10 <sup>7</sup>
Electrical lifetime for AC1:	0.7x 10 <sup>5</sup>	1x 10 <sup>5</sup>
Output indication:	yellow LED	2x yellow LED
<b>Communication</b>		
Installation BUS:	BUS	
<b>Power supply</b>		
Supply voltage/tolerance:	27 V DC, -20/+10 %	
Dissipated power:	max. 4 W	
Rated current:	30 mA (at 27 V DC)	50 mA (at 27 V DC)
Status indication unit:	green LED RUN	
<b>Connection</b>		
Data terminals:	terminal, 0.5 - 1 mm <sup>2</sup>	
Power outputs:	2x conduct. CY, Ø 2.5 mm <sup>2</sup>	6x conduct. CY, Ø 0.75 mm <sup>2</sup>
<b>Operating conditions</b>		
Operating temperature:	-20 to +55 °C	
Storage temperature:	-30 to +70 °C	
Protection degree:	IP30	
Overvoltage category:	II.	
Pollution degree:	2	
Operating position:	any	
Installation:	into installation box	
<b>Dimensions and weight</b>		
Dimensions:	49 x 49 x 21 mm	
Weight:	50 g	50 g
Standards:	EN 63044-1	

- Actuators are designed for switching of one (SA3-01B), respectively two (SA3-02B) of various appliances and loads by relay outputs (potentialless contacts).
- SA3-01B contains 1 relay with switching potentialless contact with max. load 16 A/4000 VA/AC1.
- SA3-02B contains 2 relays with switching potentialless contacts with max. load 8 A/2000 VA/AC1.
- Output contacts are separately controllable and addressable.
- Thanks to changeover contacts, the SA3-02B actuator can be used to control a 230 V drive (such as blinds, shutters or awnings), whereas by proper bridging of contacts, it is possible to secure locking hardware options while switching on phase two outputs.
- Actuators are equipped with a temperature input for connecting an external two-wire temperature sensor TC/TZ (see accessories).
- LED on front panel signals state of each output.
- SA3 is normally supplied in the option AgSnO<sub>2</sub> contact material.
- SA3-01B, SA3-02B are designed for mounting into the installation box.

**Connection**

SA3-01B

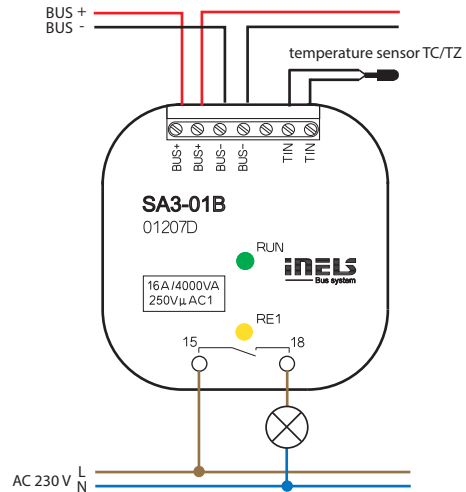

SA3-02B

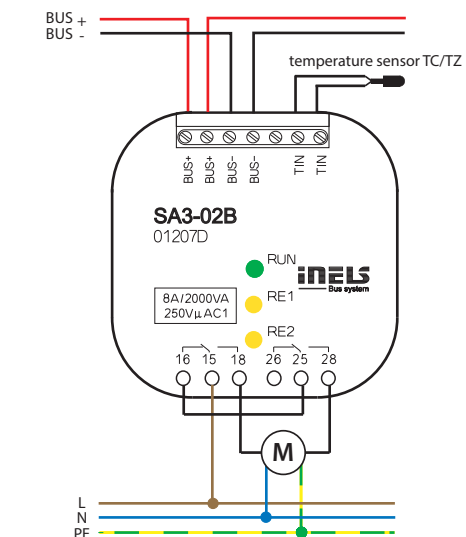



EAN code  
SA3-04M: 8595188132381  
Order Code: 3238

**Technical parameters** SA3-04M

Outputs	
Output:	4x changeover 16 A/AC1
Switching voltage:	250 V AC, 24 V DC
Switching output:	4000 VA/AC1, 384 W/DC
Surge current:	30 A; max. 4 s. at 10% duty cycle
Output relays separated from all internal circuits:	reinforced insulation (Cat. II surges by EN 60664-1)
Isolation between relay outputs RE1-3 and RE4:	reinforced insulation (Cat. II surges by EN 60664-1)
Isolation between relay outputs RE1-3:	basic insulated (Cat. II surges by EN 60664-1)
Isolates. voltage open relay contact:	1 kV
Min. switched current:	100 mA
Switching frequency/no load:	1200 min <sup>-1</sup>
Switching frequency/rated load:	6 min <sup>-1</sup>
Mechanical life:	3x 10 <sup>7</sup>
Electrical life AC1:	0.7x 10 <sup>5</sup>
Output indication:	4x yellow LED

**Communication**

Installation BUS:	BUS
-------------------	-----

**Power supply**

Supply voltage/tolerance:	27 V DC, -20/+10 %
Dissipated power:	max. 4 W
Rated current:	70 mA (at 27 V DC), from BUS
Status indication unit:	green LED RUN

**Connection**

Terminal:	max. 2.5 mm <sup>2</sup> /1.5 mm <sup>2</sup> with sleeve
-----------	---

**Operating conditions**

Air humidity:	max. 80 %
Operating temperature:	-20 to +55 °C
Storing temperature:	-30 to +70 °C
Protection degree:	IP20 device, IP40 mounting in the switchboard
Overvoltage category:	II.
Pollution degree:	2
Operation position:	any
Installation:	switchboard on DIN rail EN 60715
Design:	3-MODULE

**Dimensions and weight**

Dimensions:	90 x 52 x 65 mm
Weight:	164 g
Standards:	EN 63044-1

- SA3-04M is a switching actuator containing 4 independent relays with changeover potential-free contacts.
- Maximum load per contact is 16 A/4000 VA/AC1.
- Each of the 4 outputs contacts are individually controllable and addressable.
- All four relays are individually decorated input terminals, and therefore can switch various independent potentials.
- The actuator is designed for switching 4 various appliances or loads by relay outputs (potential free contacts).
- Thanks to changeover contacts, it can be used to control up to two drives 230 V power (such as blinds, shutters or awnings) with appropriate bridging, the contacts can secure hardware blocking the possibility of simultaneous switching of the phase on both outputs, see example of connection.
- LEDs on the front panel signal the status of each output.
- Contact status of each relay can be changed separately and manually by control buttons on a front panel.
- Switching actuators SA3 is normally supplied in the option AgSnO<sub>2</sub> contact material.
- SA3-04M in 3-MODULE version is designed for mounting into a switchboard, on DIN rail EN60715.

**Connection**

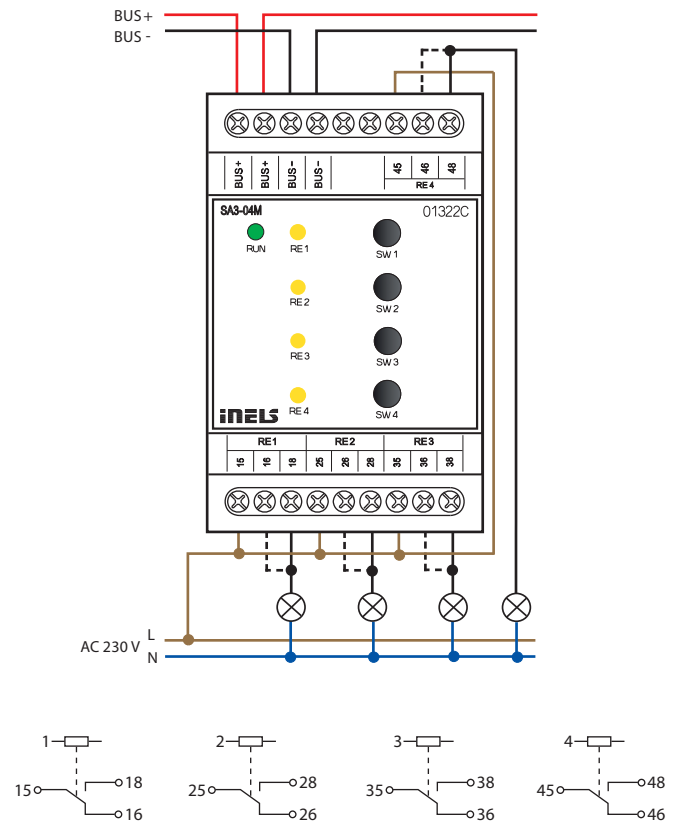



EAN code  
SA3-06M: 8595188132879  
Order Code: 3287

## Technical parameters

## SA3-06M

### Outputs

Output:	6x changeover 8 A/AC1
Switching voltage:	250 V AC, 24 V DC
Switching output:	2000 VA/AC1, 192 W/DC
Surge current:	10 A
Output relays separated from all internal circuits:	reinforced insulation (Cat. II surges by EN 60664-1)
Isolation between relay outputs COM1 and COM2:	reinforced insulation (Cat. II surges by EN 60664-1)
Isolation between individual relay outputs:	basic insulated (Cat. II surges by EN 60664-1)
Isolates voltage open relay contact:	1 kV
Max. current terminals COM1 and COM2:	16 A
Min. switched current:	100 mA/5 V DC
Switching frequency/no load:	300 min <sup>-1</sup>
Switching frequency/rated load:	15 min <sup>-1</sup>
Mechanical life:	2x 10 <sup>7</sup>
Electrical life AC1:	5x 10 <sup>4</sup>
Output indication:	6x yellow LED

### Communication

Installation BUS:	BUS
-------------------	-----

### Power supply

Supply voltage/tolerance:	27 V DC, -20/+10 %
Dissipated power:	max. 9 W
Rated current:	60 mA (at 27 V DC), from BUS
Status indication unit:	green LED RUN

### Connection

Terminal:	max. 2.5 mm <sup>2</sup> /1.5 mm <sup>2</sup> with sleeve
-----------	---

### Operating conditions

Air humidity:	max. 80%
Operating temperature:	-20 to +55 °C
Storing temperature:	-30 to +70 °C
Protection degree:	IP20 device, IP40 mounting in the switchboard
Overvoltage category:	II.
Pollution degree:	2
Operation position:	any
Installation:	switchboard on DIN rail EN 60715
Design:	3-MODULE

### Dimensions and weight

Dimensions:	90 x 52 x 65 mm
Weight:	160 g
Standards:	EN 63044-1

- The actuator is designed for switching up to six various appliances and loads with potentialless contact.
- SA3-06M is a switching actuator contains 6 independent relays with changeover potentialless contacts.
- Maximum load per contact is 8 A/2000 VA/AC1.
- Each of six output contacts are individually controllable and addressable.
- The relays are divided into two groups, the group of four relays on the bottom terminal switches the common potential, a pair of relays on top of the terminal switches the second common potential.
- The actuator is suitable for operating discontinuously controlled thermo drives in the distributor of floor heating.
- LEDs on the front panel signals the status of each output.
- Contact status of each relay can be changed separately and manually by control buttons on a front panel.
- SA3-06M is normally supplied in the option AgSnO<sub>2</sub> contact material.
- SA3-06M in 3-MODULE version is designed for mounting into a switchboard/DIN rail EN60715.

## Connection

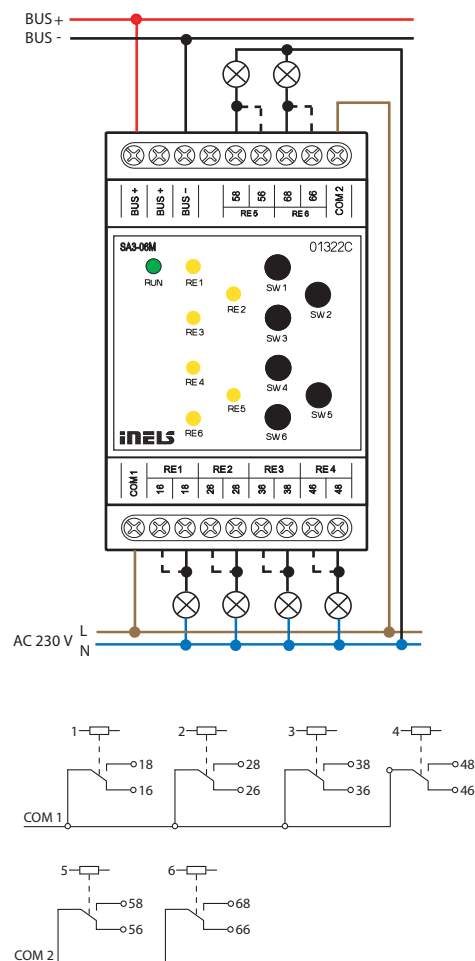



EAN code  
SA3-014M: 8595188191241  
Order Code: 9124

**Technical parameters SA3-014M**

Outputs	
Output:	14x switching 10 A/AC1
Switched voltage:	250 V AC, 30 V DC
Switched output:	2500 VA/AC, 150 W/DC
Protection:	10A (maximum output) B class circuit breaker
Peak current:	10 A
Output relays separated from all internal circuits:	reinforced insulation (Cat. II surges by EN 60664-1)
Isolation between relay outputs COM 1,2 COM 3,4 COM 5,6 COM 7,8 COM 9,10 COM 11,12:	reinforced insulation (Cat. II surges by EN 60664-1)
Isolates. voltage open relay contact:	1 kV
Max. current of one common terminal:	12 A
Minimal switched current:	100 mA/10 V DC
Switching frequency without load:	300 min <sup>-1</sup>
Switching frequency with rated load:	15 min <sup>-1</sup>
Mechanical life:	1x 10 <sup>7</sup>
Electrical life AC1:	1x 10 <sup>5</sup>
Mains voltage detection:	yes (relay switching in zero)
Output indication:	14x yellow LED
Control:	14x buttons front panel
Communication	
Installation BUS:	BUS
Status indication unit:	green LED RUN - status led for relay
Power supply	
Voltage of BUS/tolerance/nominal current:	27 V DC, -20/+10 %, 150 mA
Connection	
Terminal:	max. 2.5 mm <sup>2</sup> /1.5 mm <sup>2</sup> with sleeve
Operating conditions	
Operating temperature:	-20 to +55 °C
Storing temperature:	-30 to +70 °C
Protection degree:	IP20 device, IP40 mounting in the switchboard
Oversvoltage category:	II.
Pollution degree:	2
Operating position:	any
Installation:	switchboard on DIN rail EN 60715
Design:	6-MODULE
Dimensions and weight	
Dimensions:	90 x 105 x 65 mm
Weight:	310 g
Standards:	EN 63044-1

**Note:**  
For the protection of relay it is recommended to use protection device: 10A (maximum output) B class circuit breaker.

- SA3-014M is a switching actuator containing 14 independent relays with NO potentialless contacts, with the fact that switches the same potential. Maximal loadability of contacts is 10A/2500 VA/AC1.
- Each of the fourteen output contacts are individually controllable and addressable.
- Actuator SA3-014M is powered by an bus voltage 27V DC.
- The unit's status is indicated by the green RUN LED on the front panel - if the bus supply is connected, but there is no communication via BUS with master, the LED RUN is on continuously.
  - if the bus voltage is connected and the unit communicates by BUS, the LED RUN flashes.
- Contact status of each relay can be changed separately and manually by control buttons on a front panel.
- The unit has synchronized closing and opening of the relay in the zero-voltage of the sinusoidal waveform. The sync inputs are COM 1, 3, 5, 7, 9, 11 and 13 against the N terminal.
- SA3-014M is normally supplied in the option AgSnO2 contact material. SA3-014M in design 6-MODULE is designed to be mounted into a switchboard, on to DIN rail EN60715.
- The status of the output contacts is indicated by the LED:
  - when the output is changed, the corresponding LED lights up.

**Connection**

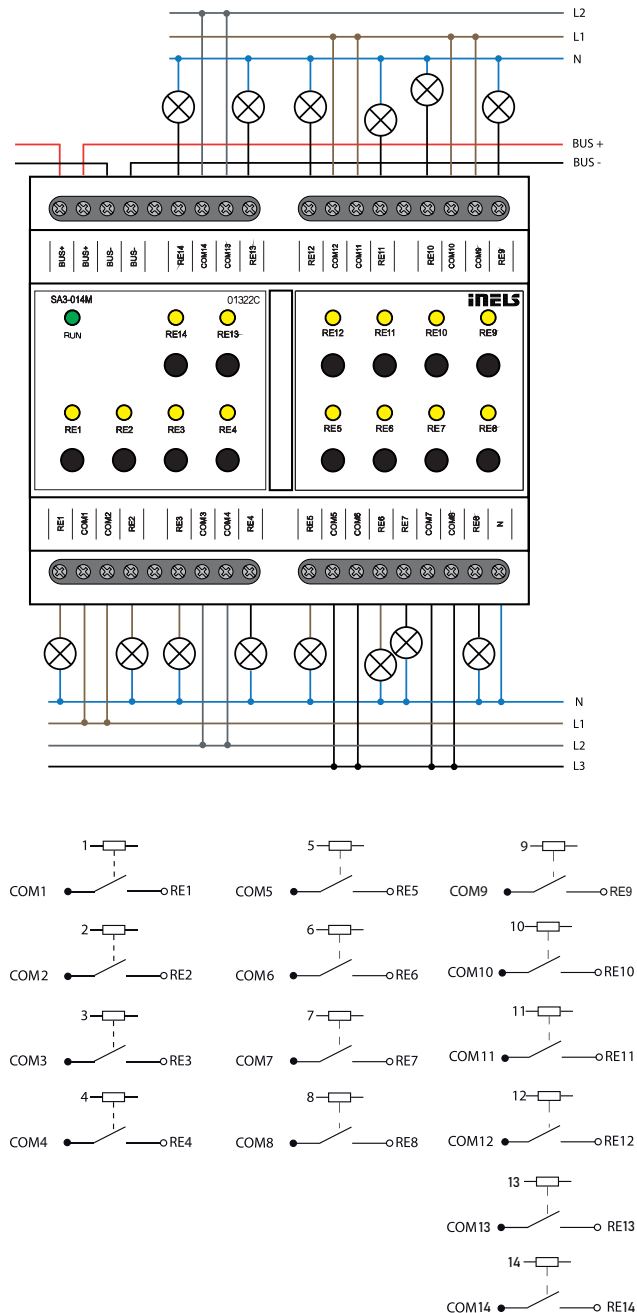

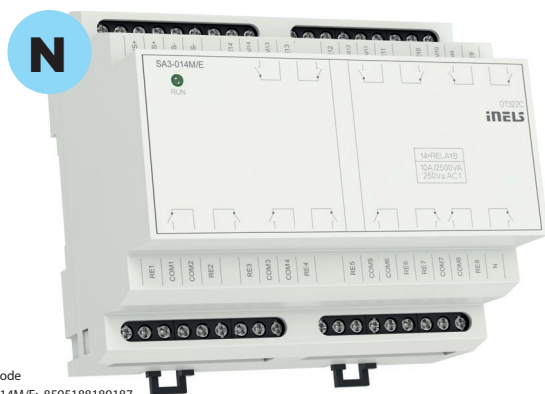

EAN code  
SA3-014M/E: 8595188189187  
Order Code: 8918

### Technical parameters

### SA3-014M/E

#### Outputs

Output:	14x switching 10 A/AC1
Switched voltage:	250 V AC, 30 V DC
Switched output:	2500 VA/AC, 150 W/DC
Protection:	10A (maximum output) B class circuit breaker
Peak current:	10 A
Output relays separated from all internal circuits:	reinforced insulation (Cat. II surges by EN 60664-1)
Isolation between relay outputs COM 1,2 COM 3,4 COM 5,6 COM 7,8 COM 9,10 COM 11,12:	reinforced insulation (Cat. II surges by EN 60664-1)
Isolates. voltage open relay contact:	1 kV
Max. current of one common terminal:	12 A
Minimal switched current:	100 mA/10 V DC
Switching frequency without load:	300 min <sup>-1</sup>
Switching frequency with rated load:	15 min <sup>-1</sup>
Mechanical life:	1x 10 <sup>7</sup>
Electrical life AC1:	1x 10 <sup>5</sup>
Mains voltage detection:	yes (relay switching in zero)
Output indication:	-
Control:	-

#### Communication

Installation BUS:	BUS
Status indication unit:	green LED RUN

#### Power supply

Voltage of BUS/tolerance/nominal current:	27 V DC, -20/+10 %, 150 mA
---	----------------------------

#### Connection

Terminal:	max. 2.5 mm <sup>2</sup> /1.5 mm <sup>2</sup> with sleeve
-----------	---

#### Operating conditions

Operating temperature:	-20 to +55 °C
Storing temperature:	-30 to +70 °C
Protection degree:	IP20 device, IP40 mounting in the switchboard
Overvoltage category:	II.
Pollution degree:	2
Operating position:	any
Installation:	switchboard on DIN rail EN 60715
Design:	6-MODULE

#### Dimensions and weight

Dimensions:	90 x 105 x 65 mm
Weight:	310 g
Standards:	EN 63044-1

#### Note:

For the protection of relay it is recommended to use protection device: 10A (maximum output) B class circuit breaker.

- SA3-014M/E is a switching actuator containing 14 independent relays with NO potentialless contacts, with the fact that switches the same potential. Maximal loadability of contacts is 10A/2500 VA/AC1.
- Each of the fourteen output contacts are individually controllable and addressable. Actuator SA3-014M/E is powered by an bus voltage 27V DC.
- The unit's status is indicated by the green RUN LED on the front panel - if the bus supply is connected, but there is no communication via BUS with master, the LED RUN is on continuously.
  - if the bus voltage is connected and the unit communicates by BUS, the LED RUN flashes.
- Contact status of each relay can be changed separately and manually by control buttons on a front panel.
- The unit has synchronized closing and opening of the relay in the zero-voltage of the sinusoidal waveform. The sync inputs are COM 1, 3, 5, 7, 9, 11 and 13 against the N terminal.
- SA3-014M/E is normally supplied in the option AgSnO2 contact material. SA3-014M/E in design 6-MODULE is designed to be mounted into a switchboard, on to DIN rail EN60715.
- SA3-014M/E is an economic option without manual control buttons on the front panel and status LEDs for the relay output. (possibility to control via iDM software).

#### Connection

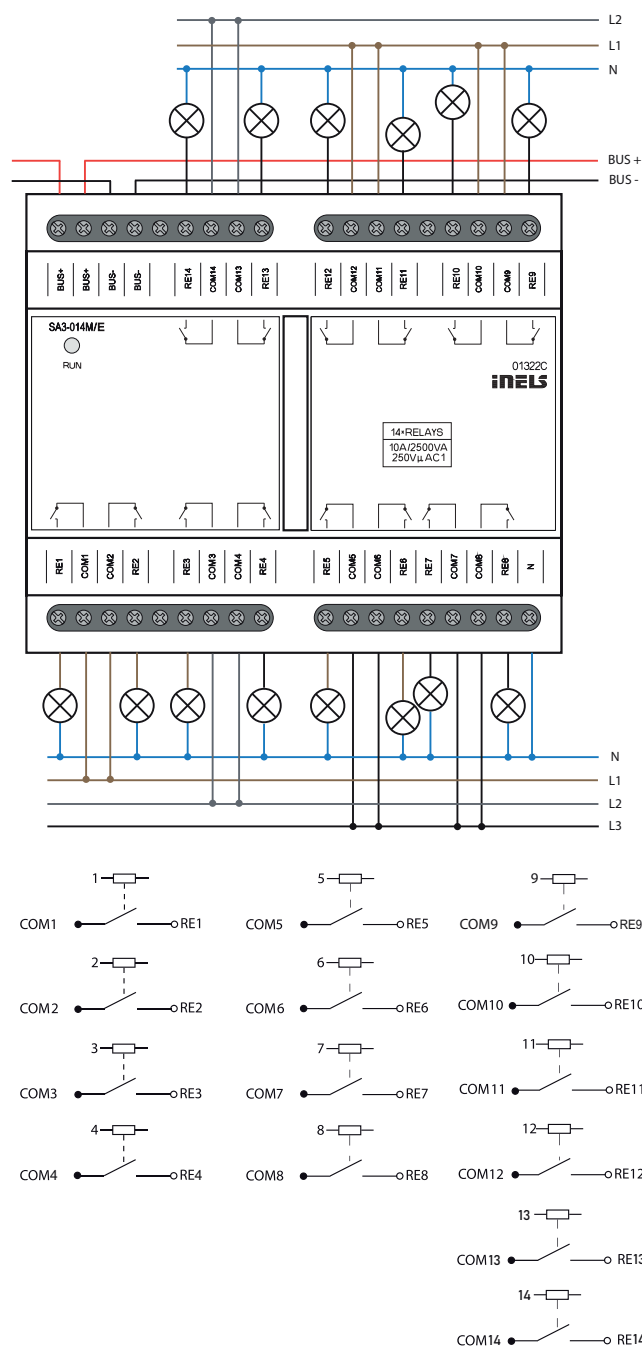



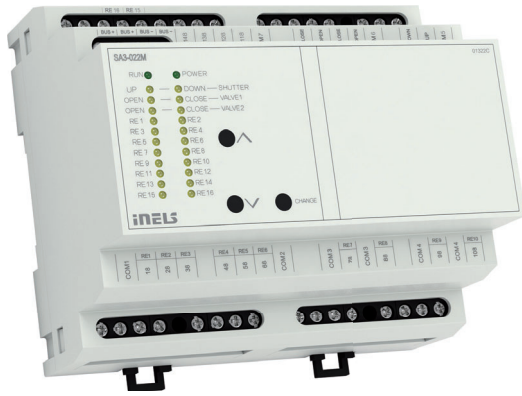

EAN code  
SA3-022M: 8595188135269  
Order Code: 3526

- Equipped with 22 relay outputs (of which 1x changeover contact – roller blinds, blinds).
- Switch lighting and socket circuits (6 A and 10 A relay) with common potential at the "COMx" terminal.
- Control of roller blinds, blinds (24 - 230 V AC/DC).
- Relay control of the fan coil unit - heating/cooling, 3 fan speeds (24 - 230 V AC/DC).
- Connection to BUS, communication with CU3.
- The front panel LEDs indicate the status of each output.
- SA3-022M in design 6-MODULE is designed to be mounted into a switchboard, onto DIN rail EN60715.

**Technical parameters SA3-022M**

**Outputs**

Output indication:	yellow LED
Output relays separated from all internal circuits:	reinforced insulation (Cat. II surges by EN 60664-1)
Insulation between COM potentials:	reinforced insulation (Cat. II surges by EN 60664-1)
Isolates. voltage open relay contact:	1 kV
<b>SSR (Electronic Relay):</b>	4x switching (VALVE1–VALVE2)
Switching voltage:	20 - 240 V AC
Switching output:	480 VA
Surge current:	20 A, t ≤ 16 ms
<b>Relay 6A:</b>	12x switching (RE1 - RE6, RE11 - RE16), 1x HW block changeover (OUT1, OUT2)
Switching voltage:	250 V AC, 24 V DC
Switching output:	1500 VA/AC1; 300 VA/AC15; 180 W/DC, AC3
Minimum switching load:	500 mW (12 V/10 mA)
Mechanical life:	10x10 <sup>6</sup>
Electrical life AC1:	6x10 <sup>4</sup>
<b>Relay 10A:</b>	4x switching (RE7 - RE10)
Switching voltage:	250 V AC, 24 V DC
Switching output:	2500 VA/AC1, 240 W/DC
Surge current:	30 A max. 4 s at 10%
Minimal switched current:	100 mA
Switching frequency without load:	1200 min <sup>-1</sup>
Switching frequency with rated load:	6 min <sup>-1</sup>
Mechanical life:	3x 10 <sup>7</sup>
Electrical life AC1:	0.7x 10 <sup>5</sup>

**Communication**

Installation BUS:	BUS
Unit status indication:	green LED POWER

**Power supply**

Supply voltage/tolerance:	27 V DC, -20/+10 %
Dissipated power:	max. 3 W
Rated current:	100 mA (at 27 V DC), from BUS
Power status indication:	green LED RUN

**Connection**

Terminal:	max. 2.5 mm <sup>2</sup> /1.5 mm <sup>2</sup> with sleeve
-----------	---

**Operating conditions**

Operating temperature:	-20 to +55 °C
Storing temperature:	-30 to +70 °C
Protection degree:	IP20 device, IP40 mounting in the switchboard
Overvoltage category:	II.
Pollution degree:	2
Operating position:	any
Installation:	switchboard on DIN rail EN 60715
Design:	6-MODULE

**Dimensions and weight**

Dimensions:	90 x 105 x 65 mm
Weight:	307 g
Standards:	EN 63044-1

**Connection**

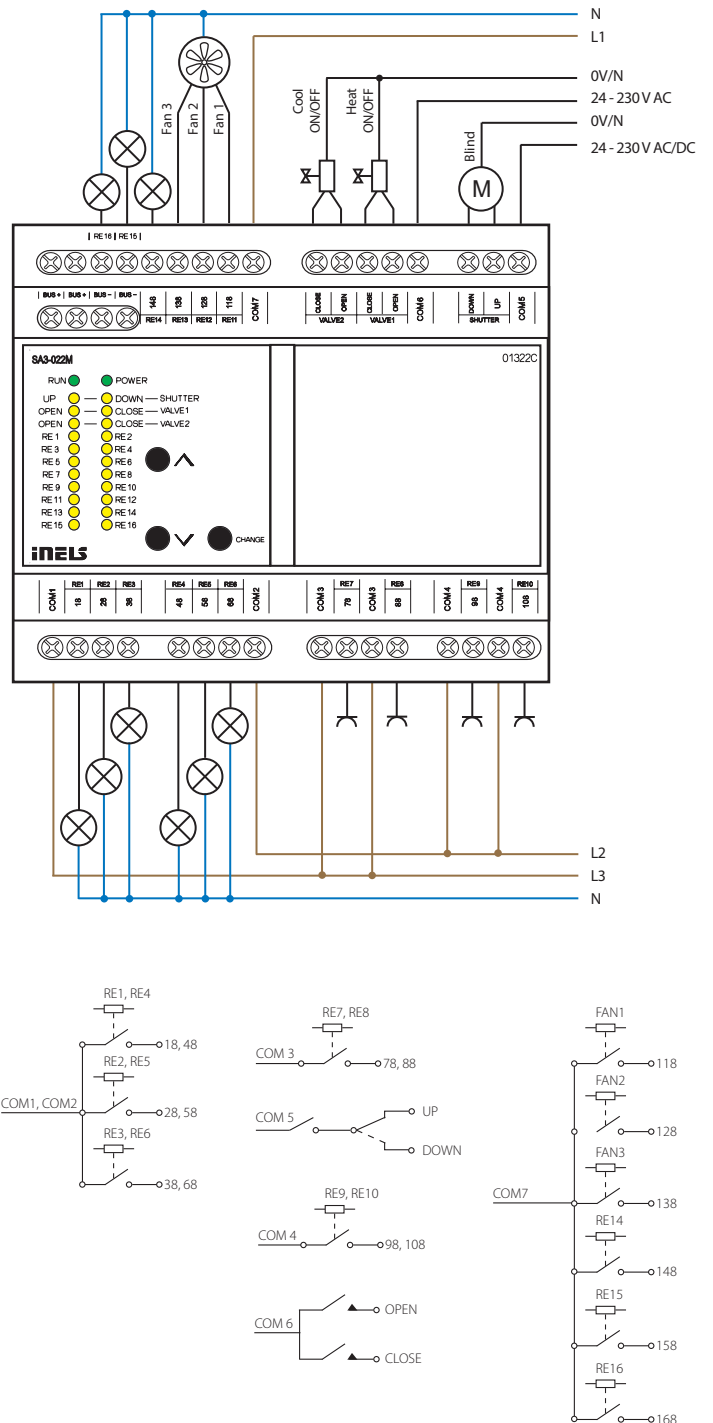

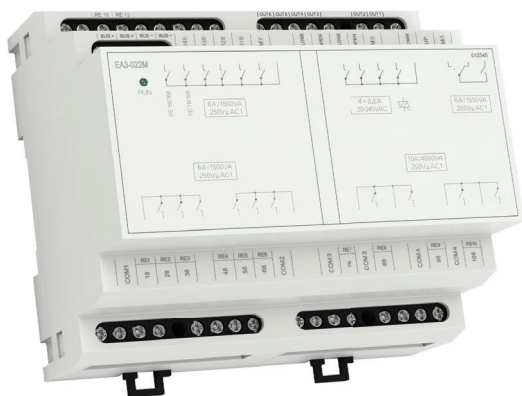

EAN code  
EA3-022M: 8595188135238  
Order Code: 3523

### Technical parameters

### EA3-022M

#### Outputs

Output relays separated from all internal circuits:	reinforced insulation (Cat. II surges by EN 60664-1)
Insulation between COM potentials:	reinforced insulation (Cat. II surges by EN 60664-1)
Isolates. voltage open relay contact:	1 kV
<b>SSR (Electronic Relay):</b>	4x switching (VALVE1-VALVE2)
Switching voltage:	20 - 240 V AC
Switching output:	480 VA
Surge current:	20 A, $t \leq 16$ ms
<b>Relay 6 A:</b>	12x switching (RE1 - RE6, RE11 - RE16), 1x HW block changeover (OUT1, OUT2)
Switching voltage:	250 V AC, 24 V DC
Switching output:	1500 VA/AC1; 300 VA/AC15; 180 W/DC, AC3
Minimum switching load:	500 mW (12 V/10 mA)
Mechanical life:	$10 \times 10^6$
Electrical life AC1:	$6 \times 10^4$
<b>Relay 10 A:</b>	4x switching (RE7 - RE10)
Switching voltage:	250 V AC, 24 V DC
Switching output:	2500 VA/AC1, 240 W/DC
Surge current:	30 A max. 4 s at 10 %
Minimal switched current:	100 mA
Switching frequency without load:	$1200 \text{ min}^{-1}$
Switching frequency with rated load:	$6 \text{ min}^{-1}$
Mechanical life:	$3 \times 10^7$
Electrical life AC1:	$0.7 \times 10^5$

#### Communication

Installation BUS:	BUS
Unit status indication:	green LED RUN

#### Power supply

Supply voltage/tolerance:	27 V DC, -20/+10 %
Dissipated power:	max. 2 W
Rated current:	100 mA (at 27 V DC), from BUS

#### Connection

Terminal:	max. 2.5 mm <sup>2</sup> /1.5 mm <sup>2</sup> with sleeve
-----------	---

#### Operating conditions

Operating temperature:	-20 to +55 °C
Storing temperature:	-30 to +70 °C
Protection degree:	IP20 device, IP40 mounting in the switchboard
Overvoltage category:	II.
Pollution degree:	2
Operating position:	any
Installation:	switchboard on DIN rail EN 60715
Design:	6-MODULE

#### Dimensions and weight

Dimensions:	90 x 105 x 65 mm
Weight:	337 g
Standards:	EN 63044-1

- Equipped with 22 relay outputs (of which 1x changeover contact – roller blinds, blinds).
- Switch lighting and socket circuits (6 A and 10 A relay) with common potential at the "COMx" terminal.
- Control of roller blinds, blinds (24 - 230 V AC/DC).
- Relay control of the fan coil unit - heating/cooling, 3 fan speeds (24 - 230 V AC/DC).
- Connection to BUS, communication with CU3.
- EA3-022M in design 6-MODULE is designed to be mounted into a switchboard, onto DIN rail EN60715.

### Connection

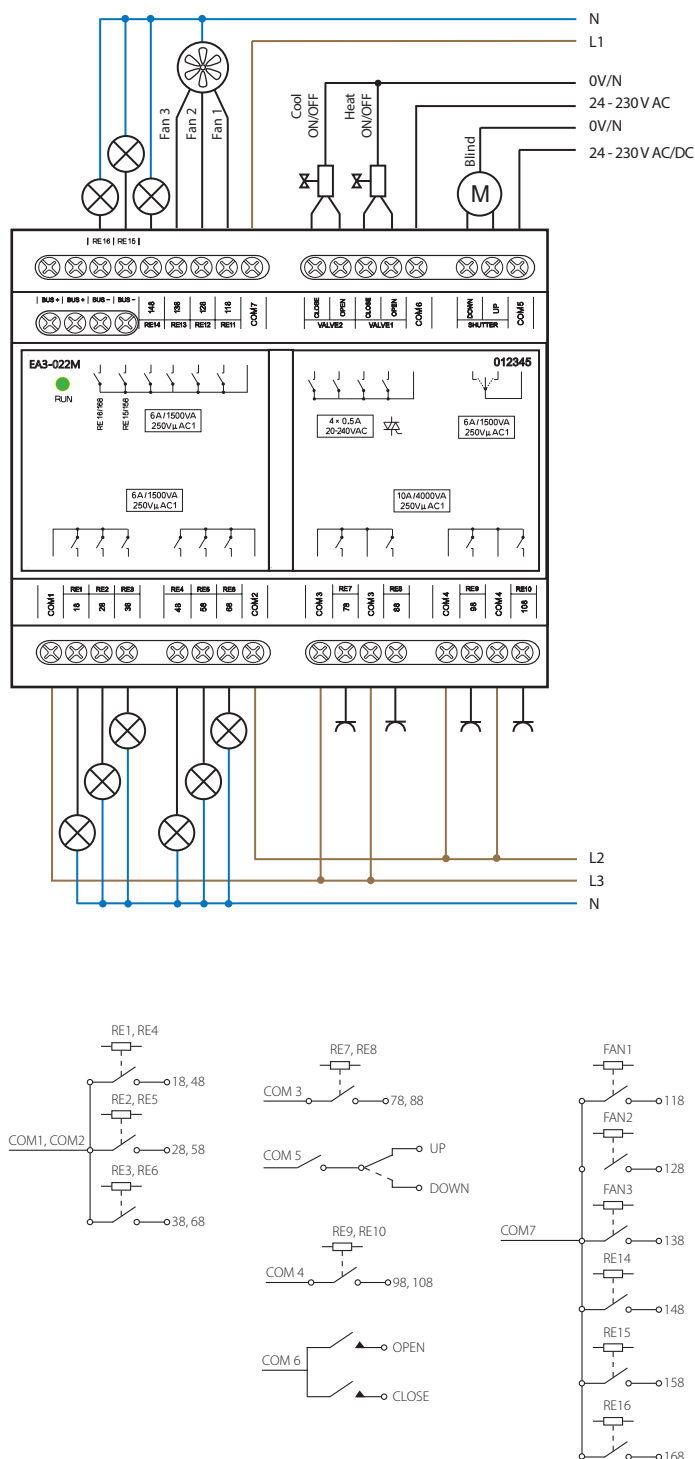



EAN code  
JA3-014M: 8595188191258  
Order Code: 9125

Technical parameters		JA3-014M
<b>Outputs</b>		
Output:	14x switching 0.5 A/AC15	
Switched voltage:	250 V AC, 30 V DC	
Switched output:	125 VA/AC15	
Protection:	10A (maximum output) B class circuit breaker	
Peak current:	10 A	
Output relays separated from all internal circuits:	reinforced insulation (Cat. II surges by EN 60664-1)	
Isolation between relay outputs COM 1,2 COM 3,4 COM 5,6 COM 7,8 COM 9,10 COM 11,12:	reinforced insulation (Cat. II surges by EN 60664-1)	
Isolates. voltage open relay contact:	1 kV	
Max. current of one common terminal:	12 A	
Minimal switched current:	100 mA/10 V DC	
Switching frequency without load:	300 min <sup>-1</sup>	
Switching frequency with rated load:	15 min <sup>-1</sup>	
Mechanical life:	1x 10 <sup>7</sup>	
Electrical life AC1:	1x 10 <sup>5</sup>	
Mains voltage detection:	yes (relay switching in zero)	
Output indication:	14x yellow LED	
Control:	14x buttons front panel	
<b>Communication</b>		
Installation BUS:	BUS	
Status indication unit:	green LED RUN - status led for relay	
<b>Power supply</b>		
Voltage of BUS/tolerance/nominal current:	27 V DC, -20/+10 %, 150 mA	
<b>Connection</b>		
Terminal:	max. 2.5 mm <sup>2</sup> /1.5 mm <sup>2</sup> with sleeve	
<b>Operating conditions</b>		
Operating temperature:	-20 to +55 °C	
Storing temperature:	-30 to +70 °C	
Protection degree:	IP20 device, IP40 mounting in the switchboard	
Overvoltage category:	II.	
Pollution degree:	2	
Operating position:	any	
Installation:	switchboard on DIN rail EN 60715	
Design:	6-MODULE	
<b>Dimensions and weight</b>		
Dimensions:	90 x 105 x 65 mm	
Weight:	310 g	
Standards:	EN 63044-1	

**Note:**  
For the protection of relay it is recommended to use protection device:  
10A (maximum output) B class circuit breaker.

- JA3-014M is an actuator designed for controlling rollers, shutters, blinds, awnings, garage doors, entrance gates, etc.
- It controls electric drives that are controlled in two directions and have a built-in limit switch.
- The unit's status is indicated by the green RUN LED on the front panel
  - if the BUS voltage is connected, but there is no communication via BUS with master, the LED RUN is on continuously.
  - if the bus voltage is connected and the unit communicates by BUS, the LED RUN flashes.
- The status of the output contacts is indicated by the Up/ Down LED:
  - when the blind/roller blind is moving up/down, the corresponding LED lights up.
  - if the number of switching operations per minute is exceeded, the corresponding LED flashes.
- Contact status of each relay JA3-014M can be changed separately and manually by control buttons on a front panel.
- The software blocking of output relay contacts can be secure using the iNELS Design Manager software.
- JA3-014M is normally supplied in the option AgSnO2 contact material.
- JA3-014M in 6-MODULE version is designed for mounting into a switchboard on DIN rail EN60715.
- The unit has synchronized closing and opening of the relay in the zero voltage of the sinusoidal waveform. The sync inputs are COM 1, 2, 3, 4, 5, 6 and 7 against the N terminal.

**Connection**

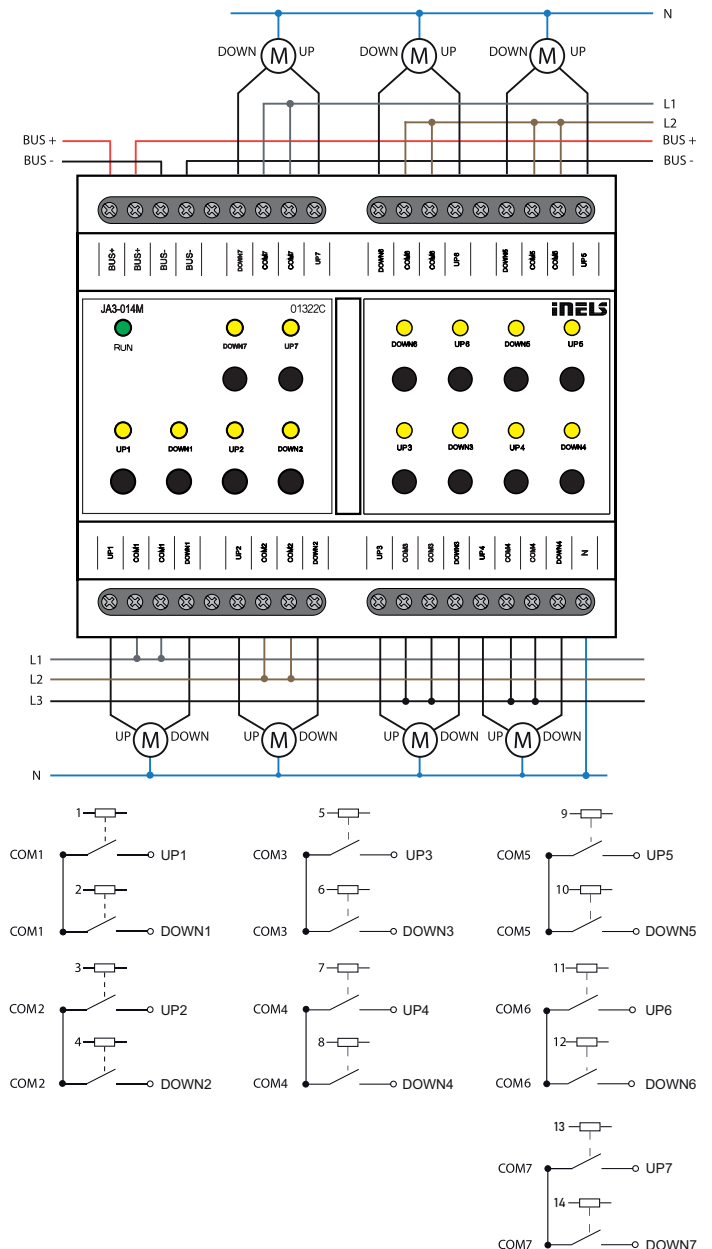

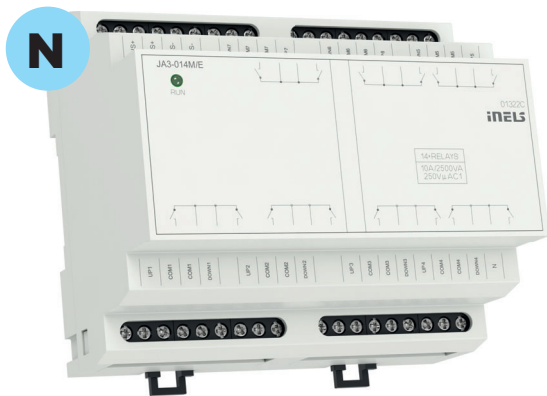

EAN code  
JA3-014M/E: 8595188189491  
Order Code: 8949

Technical parameters	JA3-014M/E
<b>Outputs</b>	
Output:	14x switching 0.5 A/AC15
Switched voltage:	250 V AC, 30 V DC
Switched output:	125 VA/AC15
Protection:	10A (maximum output) B class circuit breaker
Peak current:	10 A
Output relays separated from all internal circuits:	reinforced insulation (Cat. II surges by EN 60664-1)
Isolation between relay outputs COM 1,2 COM 3,4 COM 5,6 COM 7,8 COM 9,10 COM 11,12:	reinforced insulation (Cat. II surges by EN 60664-1)
Isolates. voltage open relay contact:	1 kV
Max. current of one common terminal:	12 A
Minimal switched current:	100 mA/10 V DC
Switching frequency without load:	300 min <sup>-1</sup>
Switching frequency with rated load:	15 min <sup>-1</sup>
Mechanical life:	1x 10 <sup>7</sup>
Electrical life AC1:	1x 10 <sup>5</sup>
Mains voltage detection:	yes (relay switching in zero)
Output indication:	-
Control:	
<b>Communication</b>	
Installation BUS:	BUS
Status indication unit:	green LED RUN
<b>Power supply</b>	
Voltage of BUS/tolerance/nominal current:	27 V DC, -20/+10 %, 150 mA
<b>Connection</b>	
Terminal:	max. 2.5 mm <sup>2</sup> /1.5 mm <sup>2</sup> with sleeve
<b>Operating conditions</b>	
Operating temperature:	-20 to +55 °C
Storing temperature:	-30 to +70 °C
Protection degree:	IP20 device, IP40 mounting in the switchboard
Oversvoltage category:	II.
Pollution degree:	2
Operating position:	any
Installation:	switchboard on DIN rail EN 60715
Design:	6-MODULE
<b>Dimensions and weight</b>	
Dimensions:	90 x 105 x 65 mm
Weight:	310 g
Standards:	EN 63044-1

**Note:**

For the protection of relay it is recommended to use protection device: 10A (maximum output) B class circuit breaker.

- JA3-014M/E is an actuator designed for controlling rollers, shutters, blinds, awnings, garage doors, entrance gates, etc.
- It controls electric drives that are controlled in two directions and have a built-in limit switch.
- The unit's status is indicated by the green RUN LED on the front panel
  - if the BUS voltage is connected, but there is no communication via BUS with master, the LED RUN is on continuously.
  - if the bus voltage is connected and the unit communicates by BUS, the LED RUN flashes.
- The software blocking of output relay contacts can be secure using the iNELS Design Manager software.
- JA3-014M/E is normally supplied in the option AgSnO2 contact material.
- JA3-014M/E in 6-MODULE version is designed for mounting into a switchboard on DIN rail EN60715.
- JA3-014M/E is an economic option without manual control buttons on the front panel and status LEDs for the relay output. (possibility to control via iDM software).
- The unit has synchronized closing and opening of the relay in the zero voltage of the sinusoidal waveform. The sync inputs are COM 1, 2, 3, 4, 5, 6 and 7 against the N terminal.

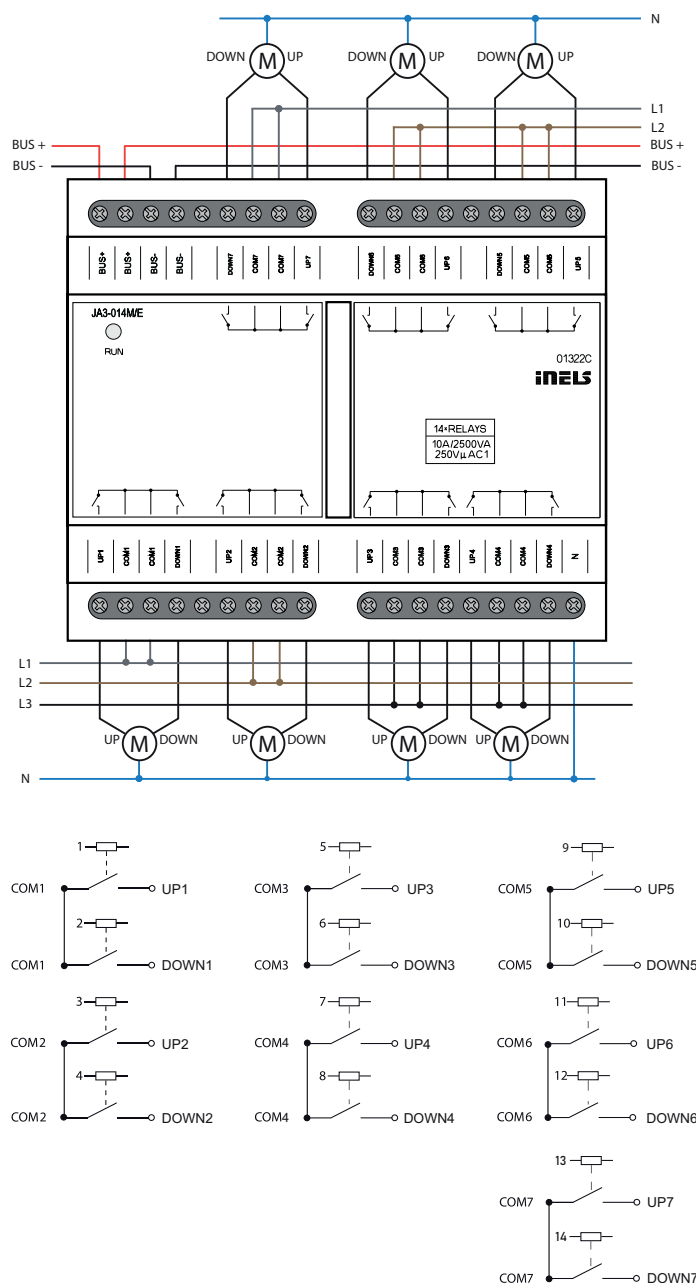
**Connection**



EAN code  
 DA3-22M: 8595188132626  
 DA3-22M/120V: 8595188133036  
 Order Code:  
 DA3-22M: 3262  
 DA3-22M/120V: 3303

Technical parameters	DA3-22M	DA3-22M/120V
----------------------	---------	--------------

Inputs		
Input:	2x inputs, switching potential L*	
Temperature measuring:	YES, input for external thermo sensor TC/TZ	
Scope and accuracy of temp. measurement:	-20 to +120 °C; 0,5 °C from the range	
Number of control buttons:	2x buttons 4x potentiometers on front panel	

Outputs		
Output:	2x contactless outputs, 2x MOSFET	
Load type:	resistive, inductive, capacitive**, LED, ESL	
Isolation BUS separated from all internal circuits:	reinforced insulation (Cat. II surges by EN 60664-1)	
Isolation voltage between particular power:	max. 500 V AC	
Minimal controlled load:	10 VA	
Maximal controlled load:	400 VA for each channel	200 VA for each channel
Output indication ON/OFF:	2x yellow LED	
Device protection:	thermal/short-term overload/ long-term overload	

Communication		
Installation BUS:	BUS	

Power supply		
Supply voltage by BUS/ tolerance:	27 V DC, -20/+10 %	
Rated current:	5 mA (at 27 V DC), from BUS	
Status indication unit:	green LED RUN	
Supply voltage for power section/tolerance:	AC 230 V (50 Hz), -15/+10 %	AC 120 V (60 Hz), -15/+10 %
Dissipated power:	max. 13 W	max. 7.5 W

Connection		
Terminal:	max. 2.5 mm <sup>2</sup> /1.5 mm <sup>2</sup> with sleeve	

Operating conditions		
Air humidity:	max. 80 %	
Operating temperature:	-20 to +35 °C	
Storing temperature:	-30 to +70 °C	
Protection degree:	IP20 device, IP40 mounting in the switchboard	
Overvoltage category:	II.	
Pollution degree:	2	
Operating position:	vertical	
Installation:	switchboard on DIN rail EN 60715	
Design:	3-MODULE	

Dimensions and weight		
Dimensions:	90 x 52 x 65 mm	
Weight:	170 g	
Standards:	EN 63044-1	

- DA3-22M is a universal dimming 2-fold actuator enabling control of brightness intensity of dimmable light sources of the type ESL, LED and RLC with power supply 230 V.
- DA3-22M has two MOSFET controlled outputs 230 V AC, maximum load is 2x 400 VA.
- Option of connecting an external temperature sensor.
- Each output channel is independently controllable and addressable.
- Type of light source is set by a switch on the front panel.
- By setting the min. brightness potentiometer on the front panel, flashing of different types of light sources is eliminated.
- DA3-22M is equipped with two inputs 230 V AC, which can be controlled by mechanical switches (buttons, relays). Inputs are galvanically connected to potential L, which is permanently at the terminals IN1 and IN2.
- By clicking on buttons on the front panel you can manually switch on or off the corresponding output.
- Electronic overcurrent and thermal protection - switch off output in case of overload short circuit and overheating.
- The power supply (potential L) must be protected by a protective element corresponding to the power input of the connected load, e.g. a safety fuse.
- During installation, it is necessary to leave on each side of the actuator at least half the module space for better cooling.
- DA3-22M in 3-MODULE version is designed for mounting into a switch-board on DIN rail EN60715.

Connection

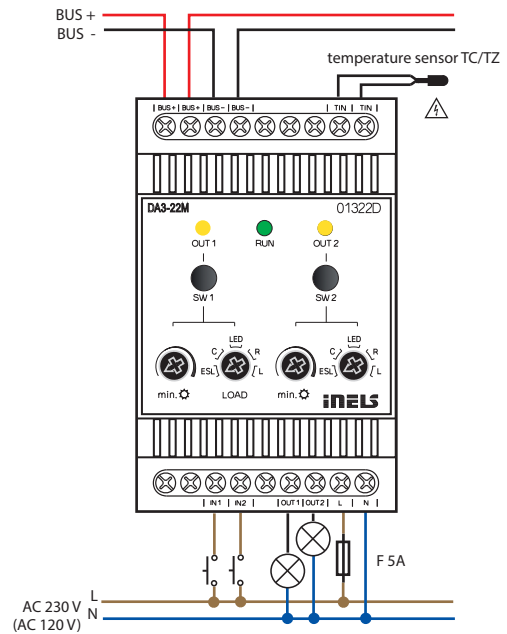

Types of connectable loads

type of source	symbol	description
R resistive		ordinary light bulb, halogen lamp
L inductive		coiled transformer for low-voltage halogen lamps
C capacitive		electronic transformer for low-voltage halogen lamps
LED		LED lamps and LED light sources, 230 V
ESL		dimmable energy-saving fluorescent tubes

\* The inputs are not galvanically isolated from the supply voltage.  
 \*\* **Attention:** It is not allowed to connect loads of inductive and capacitive character, at the same time.  
 ⚠ Input is connected to the mains voltage potential.



EAN code  
DA3-66M / 230V: 8595188182065  
DA3-66M / 120V: 8595188174459  
Order Code:  
DA3-66M / 230V: 8206  
DA3-66M / 120V: 7445

### Technical parameters DA3-66M/230V DA3-66M/120V

#### Outputs

Output:	6x contactless outputs, 2x MOSFET / channel
Load type: *	R-resistive, L-inductive, C-capacitive, LED, ESL - economical
Minimal controlled load:	10 VA
Maximal controlled load:	DA3-66M / 230V: 150 VA for each channel DA3-66M / 120V: 75 VA for each channel possibility of parallel connection of outputs
Output indication ON/OFF:	6x yellow LED
Device protection:	thermal/short-term overload/ long-term overload

#### Inputs

Wire buttons:	6x galvanically separated
Input voltage:	20–230 AC(50–60 Hz)/DC
Isolation voltage:	between inputs max. 230 VAC/DC (basic insulation) to all other internal circuits: reinforced insulation: overvoltage category II
Maximum cable length:	10 m
Glow plug connection:	no

#### Communication

Installation BUS:	BUS
-------------------	-----

#### Power supply

Supply voltage by BUS/ tolerance:	27 V DC, -20/+10 %	
Rated current:	100 mA (at 27 V DC), from BUS	
Status indication unit:	green LED RUN	
Supply voltage for power section/tolerance:	AC 230 V (50-60 Hz), -15/+10 %	AC 120 V (50-60 Hz), -15/+10 %

#### Connection

Terminal:	max. 2.5 mm <sup>2</sup> /1.5 mm <sup>2</sup> with sleeve
-----------	---

#### Operating conditions

Air humidity:	max. 80 %
Operating temperature:	-20 to +50 °C
Storing temperature:	-30 to +70 °C
Protection degree:	IP20 device, IP40 mounting in the switchboard
Overvoltage category:	II.
Pollution degree:	2
Operating position:	vertical
Installation:	switchboard on DIN rail EN 60715
Design:	6-MODULE

#### Dimensions and weight

Dimensions:	90 x 105 x 65 mm
Weight:	320 g
Standards:	EN 63044-1

\* **Attention:** It is not allowed to connect loads of inductive and capacitive character, at the same time.

- DA3-66M is a universal dimming 6-channels actuator, which is used to control the brightness of dimmable light sources such as ESL, LED and RLC with 230 V power supply.
- The DA3-66M has 6 semiconductor controlled 230 V AC outputs. The maximum possible load is 150 VA for each channel.
- The individual outputs of the dimmer can be connected in parallel and thus increase the maximum output load at the expense of the number of outputs.
- Each output channel is independently controllable and addressable.
- By setting min. brightness, the flickering of different types of light sources is eliminated.
- Min. brightness and type of load is performed using SW IDM.
- Use the control buttons on the front panel to manually control the output.
- The actuator is equipped with electronic overcurrent and thermal protection, which switches off the output in case of overload, short circuit, over-heating.
- The dimmer has 6 galvanically separated inputs which can be used both to control the dimmer and as a binary input to the iNELS system.
- The the device supply (potential L) must be protected with a safety device corresponding to the power input of the connected load, e.g. with a quick-release fuse.
- During installation, it is necessary to leave at least half a module of free space on each side of the actuator for better cooling.
- DA3-66M is in 6-MODULE version and is intended for mounting in a switch-board on DIN rail EN60715.

#### Connection

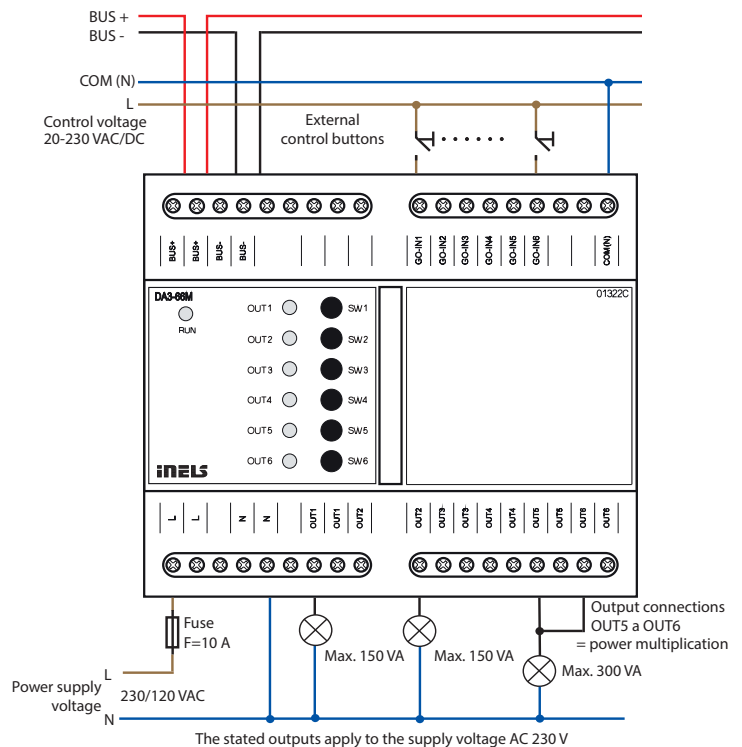

#### Types of connectable loads

type of source	symbol	description
R resistive		ordinary light bulb, halogen lamp
L inductive		coiled transformer for low-voltage halogen lamps
C capacitive		electronic transformer for low-voltage halogen lamps
LED		LED lamps and LED light sources, 230 V
ESL		dimmmable energy-saving fluorescent tubes



EAN code  
DA3-03/RGBW: 8595188184632  
Order Code: 8463

Technical parameters	DA3-03M/RGBW
<b>Output</b>	
Dimmable load:	LED strip 12 V, 24 V, 48 V; RGBW LED strip 12 V, 24 V, 48 V
Number of channels:	3x 4   12x 1
Surge current:	3x 15 A   12x 3,75 A
Switching voltage:	0-50 V DC stabilized
Dimmable performance:	max. 400 W
<b>Communication</b>	
Installation BUS:	BUS
<b>Power supply</b>	
Supply voltage by BUS/ tolerance:	27 V DC, -20/+10 %
Rated current:	5 mA (from 27 V DC), from BUS
Status indication unit:	green LED RUN
<b>Connection</b>	
Terminal:	max. 2.5 mm <sup>2</sup> /1.5 mm <sup>2</sup> with sleeve
<b>Operating conditions</b>	
Air humidity:	max. 80 %
Operating temperature:	-20 to +35 °C
Storing temperature:	-30 to +70 °C
Protection degree:	IP20 device, IP40 mounting in the switchboard
Pollution degree:	2
Operating position:	vertical
Installation:	switchboard on DIN rail EN 60715
Design:	3-MODULE
<b>Dimensions and weight</b>	
Dimensions:	90 x 52 x 65 mm
Weight:	170 g
Standards:	EN 63044-1

- The dimmer for LED strips is used for independent control of 12 channels, so it can be connected to, for example:

- 3 RGBW led strips or 3 RGB led strips
- 12 single colour LED strips
- combination of RGB, RGBW & LED strips

- The 3-module design of the device with mounting in the switchboard allows the connection of a dimmable load of 3x 15 A or 12x 3.75 A, which represents, for example: 3 pieces of RGBW LED strips 24 V 20W/m = max 18m.
- The dimmer is controlled by the central unit of the iNELS system.
- The power supply of the LED strip is in the range of 0-50V DC.
- Each of the output channels is separately controllable and addressable.
- The actuator is equipped with electronic thermal protection, which switches off the output in case of overheating.
- During installation, it is necessary to leave at least half a module of free space on each side of the actuator for better cooling.
- DA3-03M/RGBW in 3-MODUL design is intended for installation in a switchboard on an EN60715 DIN rail.

Connection

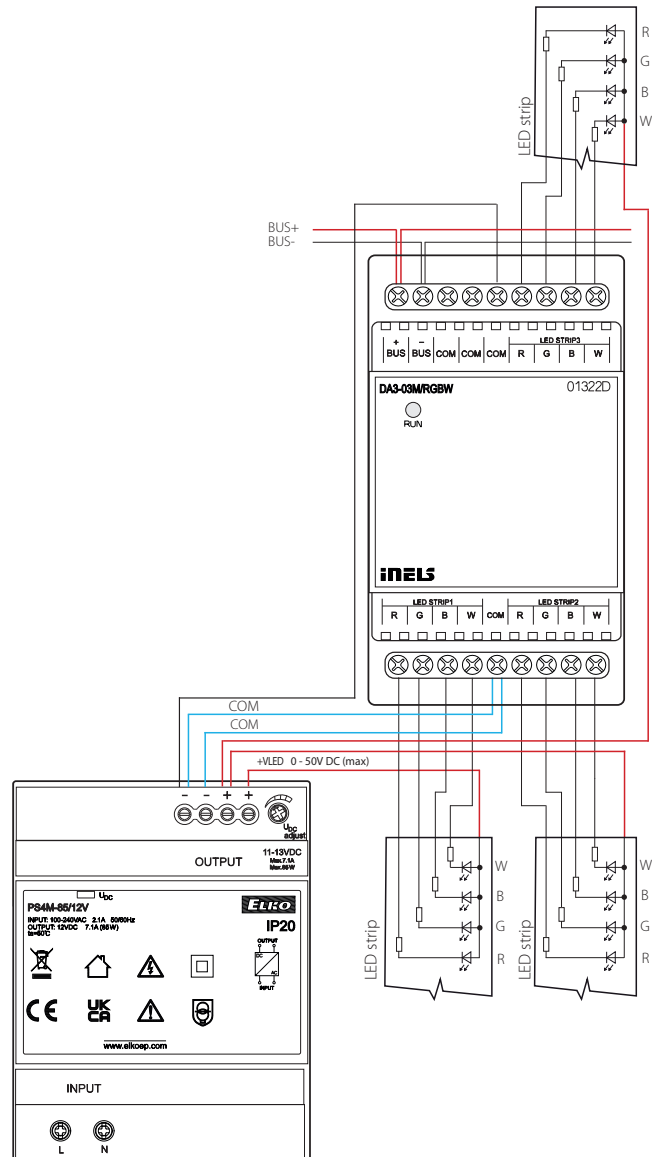



EAN code  
IM3-40B: 8595188132312  
IM3-80B: 8595188132329

Order Code:  
IM3-40B: 3231  
IM3-80B: 3232

Technical parameters	IM3-40B	IM3-80B
<b>Inputs</b>		
Input:	4x* IN1, IN2**	8x* IN1- IN5**
Max. frequency pulse reading:	20 Hz	
Temperature measuring:	yes, input for external thermo sensor TC/TZ	
Range/accuracy of thermomeasuring:	-20 to +120 °C/0.5 °C from the range	
<b>Outputs</b>		
Output voltage/current:	12 V DC/75 mA, for supplying EZS sensors	
<b>Communication</b>		
Installation BUS:	BUS	
Status indication unit:	green LED RUN	
<b>Power supply</b>		
Supply voltage/tolerance:	27 V DC, -20/+10 %	
Dissipated power:	max. 1 W	
Rated current:	20 mA (at 27 V DC), from BUS	
Rated current of unit for full load on output 12 V DC:	60 mA	100 mA
<b>Connection</b>		
Terminal:	0.5-1 mm <sup>2</sup>	
Inputs:	6x conductors CY length 90 mm	x
<b>Operating conditions</b>		
Operating temperature:	-20 to +55 °C	
Storing temperature:	-30 to +70 °C	
Protection degree:	IP30	
Overvoltage category:	II.	
Pollution degree:	2	
Operating position:	any	
Installation:	into installation box	
<b>Dimensions and weight</b>		
Dimensions:	49 x 49 x 13 mm	
Weight:	32 g	27 g
Standards:	EN 63044-1	

\* NO or NC against GND(-)  
\*\* are balanced inputs

- Binary input units IM3-40B and IM3-80B are used for connection of 4 or 8 devices with potential-less contacts (switches, buttons, switches of other design, PIR detectors, fire and gas detectors, etc.).
- Part of the inputs can be used as a balanced for alarm detectors:
  - IM3-40B – inputs IN1, IN2
  - IM3-80B – inputs IN1 – IN5
- Contacts of external devices connected to the inputs of the unit can be NO or NC - input parameters are configured in the software iDM3.
- Within the internal ESS configured in the iDM3 software, inputs must be set to balance or double balance.
- The units generate a supply voltage of 12 V DC/75 mA for powering external intrusion detectors, so they can power PIR detectors, fire and gas detectors.
- Active use 12 V DC output for powering detectors increases the nominal consumption of units from BUS (see technical data).
- The units can be used for counting pulses of energy meters with pulse output.
- The units are equipped with a temperature input for connecting an external two-wire temperature sensor TC/TZ (see accessories).
- IM3-40B, IM3-80B in case type B are designed for mounting into a installation box.

Connection

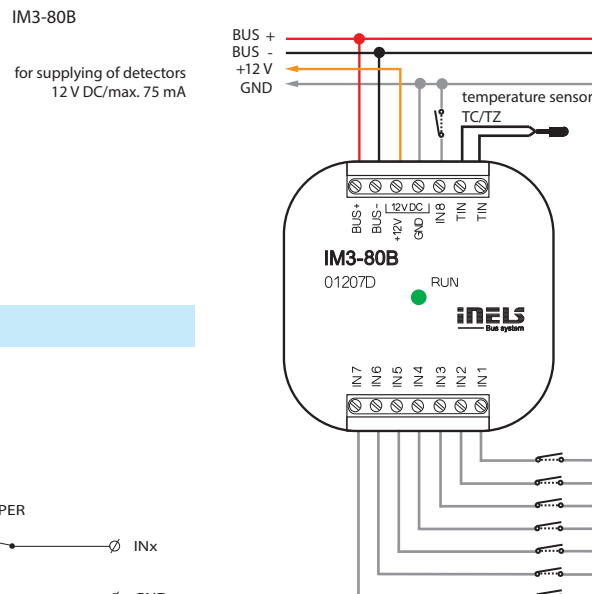
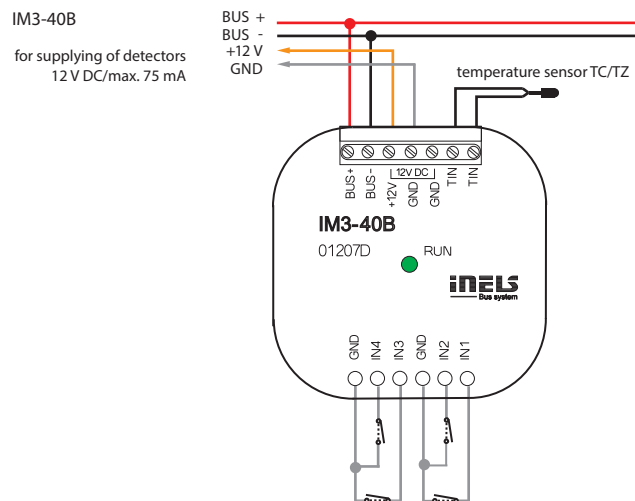

Balanced input

Simple:

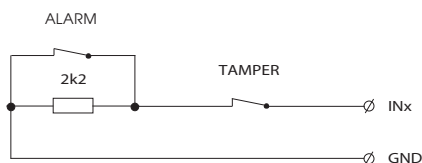

Double:

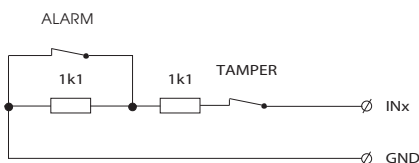





EAN code  
IM3-140M: 8595188132459  
Order Code: 3245

Technical parameters		IM3-140M
<b>Inputs</b>		
Input:	14x NO or NC against GND (-) IN1 - IN7 - are balanced inputs	
Max. frequency pulse reading:	20 Hz	
<b>Outputs</b>		
Output (power supply 12 V for sensors):	12 V DC/150 mA	
<b>Communication</b>		
Installation BUS:	BUS	
Data transfer indication:	green LED	
<b>Power supply</b>		
Supply voltage/tolerance:	27 V DC, -20/+10 %	
Dissipated power:	max. 1 W	
Rated current:	25 mA (at 27 V DC), from BUS	
Rated current for full load on output 12 V DC:	100 mA	
<b>Connection</b>		
Terminal:	max. 2.5 mm <sup>2</sup> /1.5 mm <sup>2</sup> with sleeve	
<b>Operating conditions</b>		
Air humidity:	max. 80 %	
Operating temperature:	-20 to +55 °C	
Storing temperature:	-30 to +70 °C	
Protection degree:	IP20 device, IP40 mounting in the switchboard	
Overvoltage category:	II.	
Pollution degree:	2	
Operating position:	any	
Installation:	into a switchboard rail to DIN EN 60715	
Design:	3-MODULE	
<b>Dimensions and weight</b>		
Dimensions:	90 x 52 x 65 mm	
Weight:	104 g	
Standards:	EN 63044-1	

- Binary input unit IM3-140M is designed to connect up to 14 devices with potentialless contact (such as switches, buttons of other designs, fire and glass detectors and others).
- Inputs IN1 - IN7 can be balanced.
- Contacts of external devices connected to the inputs of the drive can be NO or NC - Input parameters are configured in the software iDM3.
- Inputs must be configured as balanced or double balanced - in an internal Electronic security system configured in iDM3 software.
- The unit generates a supply voltage of 12 V DC/150 mA for powering external detectors, so it can power PIR detectors, fire and gas detectors.
- Active use 12 V DC output for powering detectors increases the nominal consumption units from BUS (see technical data).
- The unit can be used for counting pulses of energy meters with pulse output.
- IM3-140M in 3-MODULE is designed for switchboard mounting on DIN rail EN60715.

Connection

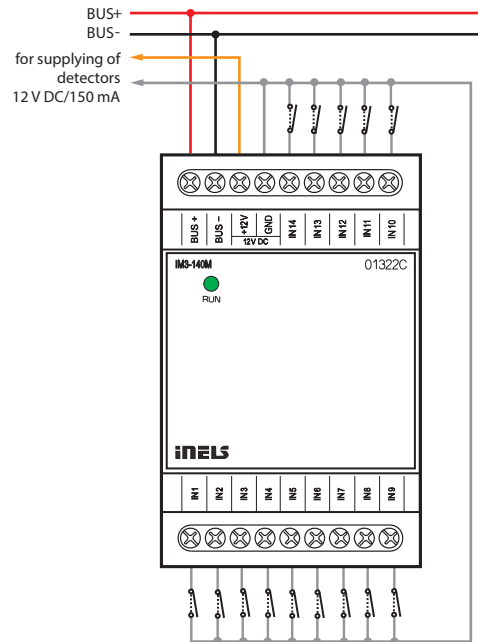

Balanced input

Simple:

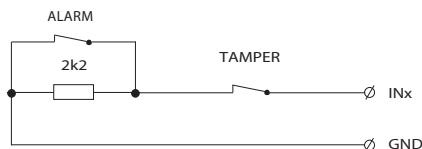

Double:

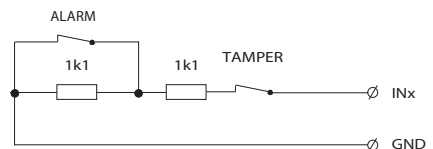



EAN code  
TI3-40B: 8595188132695  
Order Code: 3269

### Technical parameters

### TI3-40B

#### Input

Temperature input for temperature measuring:	4x inputs for external thermo sensor*
Temperature measurement range:	by type of sensor, prob from -50°C to 400°C
Converter resolution:	15 bit

#### Communication

Installation BUS:	BUS
Status indication unit:	green LED RUN

#### Power supply

Supply voltage/tolerance:	27 V DC, -20/+10 %
Dissipated power:	max. 1 W
Rated current:	20 mA (at 27 V DC), from BUS

#### Connection

Terminal:	0.5 mm <sup>2</sup> - 1 mm <sup>2</sup>
-----------	---

#### Operating conditions

Operating temperature:	-20 to +55 °C
Storing temperature:	-30 to +70 °C
Protection degree:	IP30
Overvoltage category:	II.
Pollution degree:	2
Operating position:	any
Installation:	into installation box

#### Dimensions and weight

Dimensions:	49 x 49 x 13 mm
Weight:	27 g
Standards:	EN 63044-1

\*TC, TZ, Ni1000, Pt1000, Pt100, see accessories

- The unit is designed for connection of up to four (TI3-40B) external temperature sensors.
- Units range TI3 support the connection of the following temperature sensors:
  - TC/TZ - 2-wire connections
  - Ni1000, Pt1000, Pt100 - 2-wire and 3-wire connections
- Used in when necessary to take temperatures from different places (for example large floor heating – diagonal layout of sensors, floor/space, indoor/outdoor temperature, technological device – boiler, solar heating etc.)
- Status of units indicated by green RUN LED on the front panel:
  - if the supply voltage is connected (units are powered via the BUS), but there is no communication with the master, RUN LED is lit continuously.
  - if the supply voltage is connected and the unit communicates via standard BUS, RUN LED flashes.
- TI3-40B in version B is designed for mounting into an installation box.

### Connection

#### TI3-40B

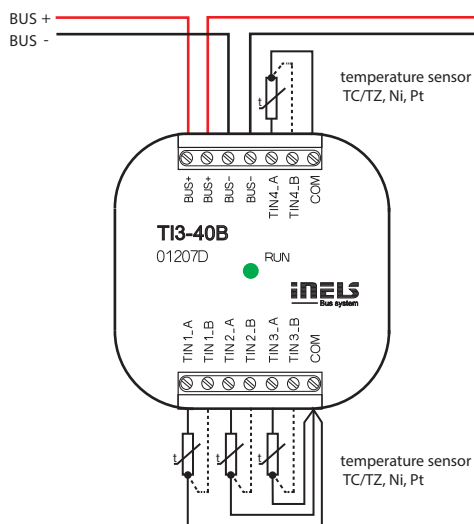

### Connection options

#### 2-wire

- it is necessary to connect terminals TIN\_B and COM

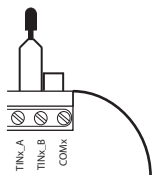

#### 3-wire

- connection of the sensor needs to be done according to the technical specifications

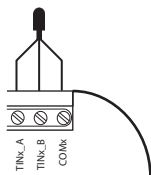

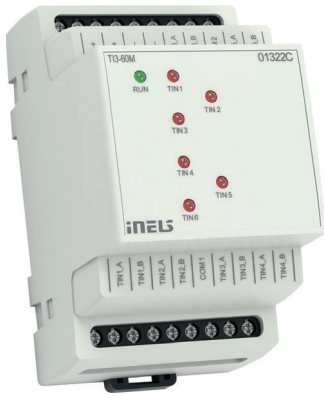

EAN code  
 TI3-60M: 8595188132893  
 Order Code: 3289

**Technical parameters** **TI3-60M**

Inputs	
Temperature input for temperature measuring:	6x input for external temperature sensor TC, TZ, Ni1000, Pt1000, Pt100 see accessories
Temperature measurement range:	by type of sensor, probe from -50°C to 400°C
Converter resolution:	15 bit
Indication of exceeding the range or interruption of the sensor:	6x red LED
Communication	
Installation BUS:	BUS
Status indication unit:	green LED RUN
Power supply	
Supply voltage/tolerance:	27 V DC, -20/+10 %
Dissipated power:	max. 1 W
Rated current:	45 mA (at 27 V DC), from BUS
Connection	
Terminal:	max. 2.5 mm <sup>2</sup> /1.5 mm <sup>2</sup> with sleeve
Operating conditions	
Operating temperature:	-20 to +55 °C
Storing temperature:	-30 to +70 °C
Protection degree:	IP20 device, IP40 mounting in the switchboard
Overvoltage category:	II.
Pollution degree:	2
Operating position:	any
Installation:	into a switchboard rail to DIN EN 60715
Design:	3-MODULE
Dimensions and weight	
Dimensions:	90 x 52 x 65 mm
Weight:	111 g
Standards:	EN 63044-1

- Unit TI3-60M is designed to connect up to six external temperature sensors.
- Units range TI3 support the connection of the following temperature sensors:
  - TC/TZ - 2-wire connections
  - Ni1000, Pt1000, Pt100 - 2-wire and 3-wire connections
- It is used in cases where it is necessary to read the temperature, eg floor/room, indoor/outdoor temperature, process equipment - boiler, solar heating, etc.
- Unit status is indicated by green RUN LED on the front panel:
  - if the supply voltage is connected (the unit is powered via the BUS), but there is no communication with the master, RUN LED is lit continuously.
  - if the supply voltage is connected and the unit communicates via standard BUS, RUN LED flashes.
- The status on individual temperature inputs is indicated by the relevant red LED on the front panel:
  - LIT - temperature sensor disconnection
  - FLASHES - exceeding of the temperature range
  - UNLIT - ok
- TI3-60M in 3-MODULE is designed for switchboard mounting on DIN rail EN60715.

**Connection**

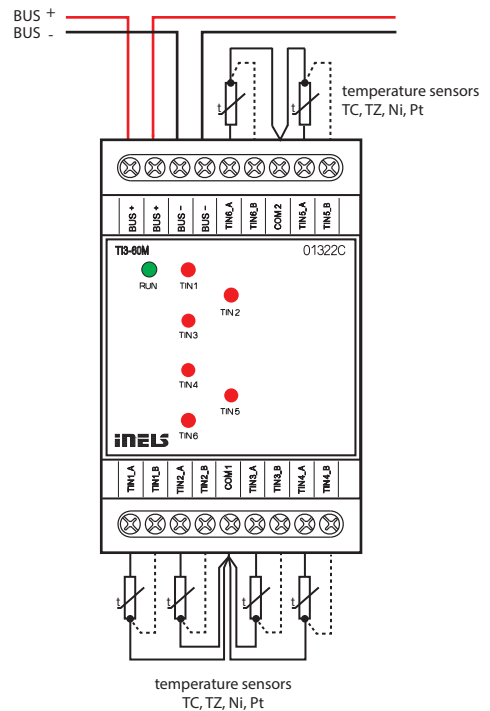

**Connection options**

**2-wire**  
 - it is necessary to connect terminals TIN\_B and COM



**3-wire**  
 - connection of the sensor needs to be done according to the technical specifications

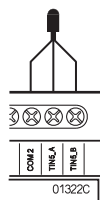

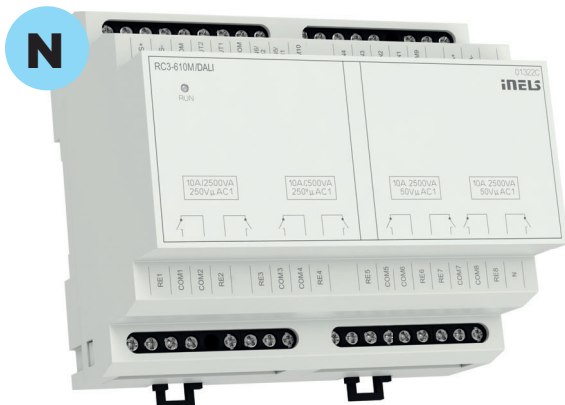

EAN code  
RC3-610M/DALI: 8595188184663  
Order Code: 8467

Technical parameters		RC3-610M/DALI
<b>Output</b>		
<b>Relay</b>		8x NO/switch 10 A/AC1
Switched voltage:		250VAC , 30VDC
Switched power:		2500 VA/AC1, 150 W/DC
Peak current:		10A AC1 , 5A DC
Relay outputs separated from of all internal circuits:		reinforced insulation (Overvoltage cat. II according to EN 60664-1)
Isolation between COM1,2 a COM3,4 a COM5,6,7,8 *		basic insulation (cat. overvoltage II according to EN 60664-1) max. 400AC
Isolation voltage of the open relay contact:		1 kV
Max. current through one common terminal:		16 A
Minimum switching current:		100 mA/10 V DC
Mechanical service life:		10 000 000
Electrical life AC1:		100 000
<b>Analog</b>		
Analog outputs:		AO1, AO2
Voltage analogue. output/ max. current:		2x 0(1) - 10 V/10 mA
<b>Inputs</b>		
Input DIN:		6x DIN (digital input) or 4x DIN + 2x TIN (temperature input) **
DIN sampling rate:		20 Hz
DIN common wire:		COM9, COM10
TIN common wire:		TINCOM
<b>Communication</b>		
<b>DALI</b>		
Output interface:		DALI
DALI addresses (max.):		16
Internal DALI source:		yes, max. 64 mA
<b>BUS</b>		
Installation bus:		BUS
Indication of unit status:		Green LED RUN
<b>Power</b>		
Internal DALI supply terminals:		terminals COM8 and N
Internal DALI supply voltage:		100-240V 50/60H max.0.1A
Power dissipation:		3 W
<b>Connection</b>		
Terminal plate:		max. 2.5 mm <sup>2</sup> /1.5 mm <sup>2</sup> with core

\* adjacent COM terminals (COM1 and 2, COM3 and 4, COM5 and 6, COM7 and 8) must be at the same potential  
 \*\* input function is set during configuration  
 \*\*\* ACOM and COM9 terminals are at BUS potential

To provide power to the Dali bus via DA+ and DA-, it is essential to establish a 230V connection between Com8 and N.

- The RC3-610M/DALI is an I/O actuator equipped with 6 binary inputs, of which 2 can be configured as temperature inputs and 8 independent relays with switching potential-free and potential contacts. It also includes two analog outputs 0(1)-10V with a load capacity of up to 10 mA.
- Binary inputs RC3-610M/DALI are used for connecting up to 6 devices with a non-decimal contact (such as switches, switches, buttons of other designu, EZS and EPS detectors and others).
- Temperature inputs support the connection of TC/TZ temperature sensors in a 2-wire connection for temprature sensing needs.
- The actuator is designed for switching up to eight different appliances and loads by relay output (potential-free contact).
- The maximum load capacity of the relay contacts is 10 A/2500 VA/ AC1. Each of the output contacts is individually controllable. Relays are divided into four pairs, where each pair switches on its common potential.
- The DALI system BUS allows control of up to 16 independent DALI (Digital Addressable Lighting Interface) ballast addresses for fluorescent, LED and other luminaires.
- Analog outputs are considered for use with thermoregulation heads, air-conditioning ventilation flaps, various other dimmers or other devices with an analog control voltage of 0-10 V or 1-10 V.
- The parameters of all configurable inputs and outputs are set in the iNELS Designer & Manager configuration software environment, which is designed for Windows 7, 8 and 10 operating systems.
- RC3-610M/DALI in 6-MODULE version is designed for mounting into a switchboard on DIN rail EN60715.

Operating conditions	
Working temperature:	-20 to +55 °C
Storage temperature:	-30 to +70 °C
Degree of protection:	IP20 device, IP40 with cover in the control cabinet
Surge category:	II.
Degree of pollution:	2
Working position:	any
Installation:	to the control cabinet for DIN rail EN 60715
Design:	6-MODULE
Dimensions and weight	
Dimensions:	90 x 105 x 65 mm
Weight:	310 g
Standards:	EN 63044-1

**Connection**

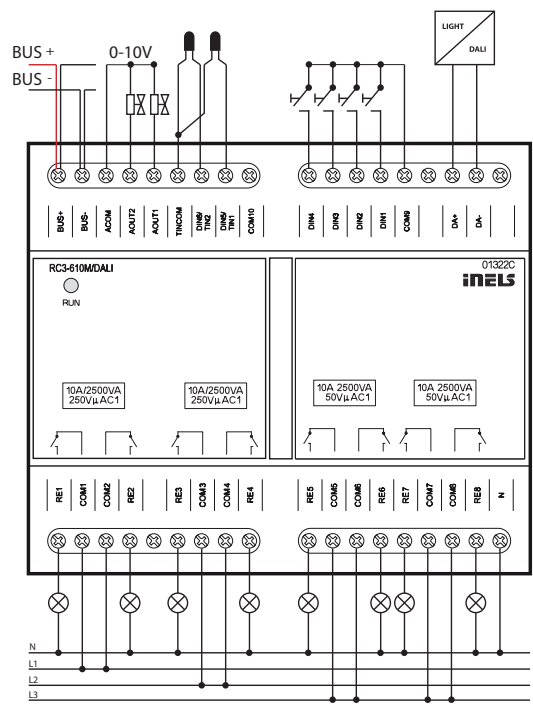

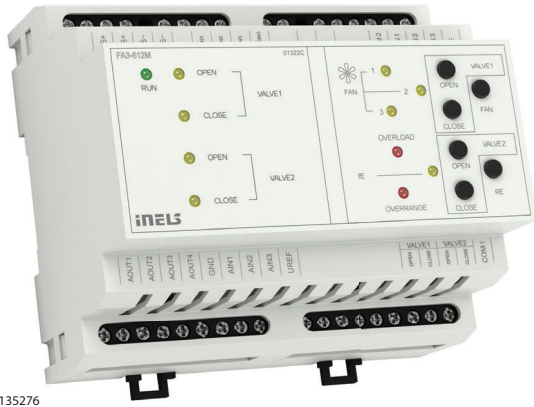

EAN code  
FA3-612M: 8595188135276  
Order Code: 3257

- FA3-612M is a unit (actuator) designed to control fancoil units using analogue/digital inputs and analog/relay outputs.
- Analog inputs for temperature, voltage or current measurement (Uref reference voltage can also be used).
- The digital inputs are galvanically isolated with positive logic (Sink) in the 24-230 V AC/DC voltage range.
- Analog outputs 0-10 V.
- Connection to the installation BUS.
- Buttons for closing/opening the valve, fan and heating relay.
- The LEDs on the front panel indicate FAN, RE, VALVE1, VALVE2, OVER-RANGE, and OVERLOAD status.
- FA3-612M in 6-MODULE version is designed for mounting into a switch-board, on DIN rail EN60715.

Technical parameters		FA3-612M
<b>Input</b>		
<b>Analog inputs:</b>	3x voltage, current or temperature input	
Number of inputs:	3	
Galv. separation from inner circuits:	no	
Diagnostic:	indication red LED OVERRANGE (exceeding the range, interruption of a sensor or overload of Uref output)	
Common terminal:	GND	
Converter resolution:	14 bits	
Input resistance		
- for voltage ranges:	approx. 150 kΩ	
- for current ranges:	100 Ω	
Types of inputs/measuring ranges*:	<b>Voltage (U):</b> 0 ÷ +10 V (U) ; 0 ÷ +2 V (U) <b>Current (I):</b> 0 ÷ +20 mA (I) ; 4 ÷ +20 mA (I) <b>temperature:</b> input at ext. temperature sensor TC, TZ, Ni1000**, Pt1000**, Pt100** see accessories/ according to used sensor from -30 °C to 250 °C	
<b>Digital inputs:</b>	3x switching or expansion, positive logic (SINK)	
Input voltage:	20 - 240 V AC (50 - 60 Hz)/DC	
Galv. separation from internal circuits:	yes	
Common lead:	GO COM3	
<b>Outputs</b>		
<b>Analog:</b>	4x (A_OUT1 - A_OUT4)	
Voltage analog. output/max. Current:	4x 0(I) - 10 V/10 mA	
<b>Uref reference voltage outputs</b>		
Voltage/Current Uref:	10 V DC/100 mA	
Output overload indication:	red LED OVERLOAD	
<b>SSR (Electronic Relay):</b>	4x (VALVE1 - VALVE2)	
Switching voltage:	20 - 240 V AC	
Switching capacity:	480 VA	
Peak current:	20 A, t ≤ 16 ms	
Output indication:	yellow LED	
<b>Relay 6A:</b>	4x (FAN1-FAN3, RE)	
Switching voltage:	250 V AC, 24 V DC	
Switching capacity:	1500 VA/AC1; 300 VA/AC15; 180 W/DC, AC3	
Relay outputs separated from all internal circuits:	reinforced insulation (Cat. II surges by EN 60664-1)	
Minimum switching load:	500 mW (12 V/10 mA)	
Mechanical life:	10x10 <sup>6</sup>	
Electrical life AC1:	6x10 <sup>4</sup>	
Output indication:	yellow LED	
<b>Communication</b>		
Installation BUS:	BUS	
Status indication unit:	green LED RUN	
<b>Power supply</b>		
Supply voltage/tolerance/ rated current:	27 V DC, -20/+10 %, 5 mA	
Supply voltage of power section (relay) tolerance/ nominal current:	AC 230 V (50 Hz), -15/+10 %, 20 mA	
Dissipated power:	max. 1 W	

Connection	
Terminal:	max. 2.5 mm <sup>2</sup> /1.5 mm <sup>2</sup> with sleeve
<b>Operating conditions</b>	
Operating temperature:	-20 to +55 °C
Storing temperature:	-30 to +70 °C
Protection degree:	IP20 device, IP40 mounting in the switchboard
Overvoltage category:	II.
Pollution degree:	2
Operating position:	any
Installation:	switchboard on DIN rail EN 60715
Design:	6-MODULE
<b>Dimensions and weight</b>	
Dimensions:	90 x 105 x 65 mm
Weight:	307 g
Standards:	EN 63044-1

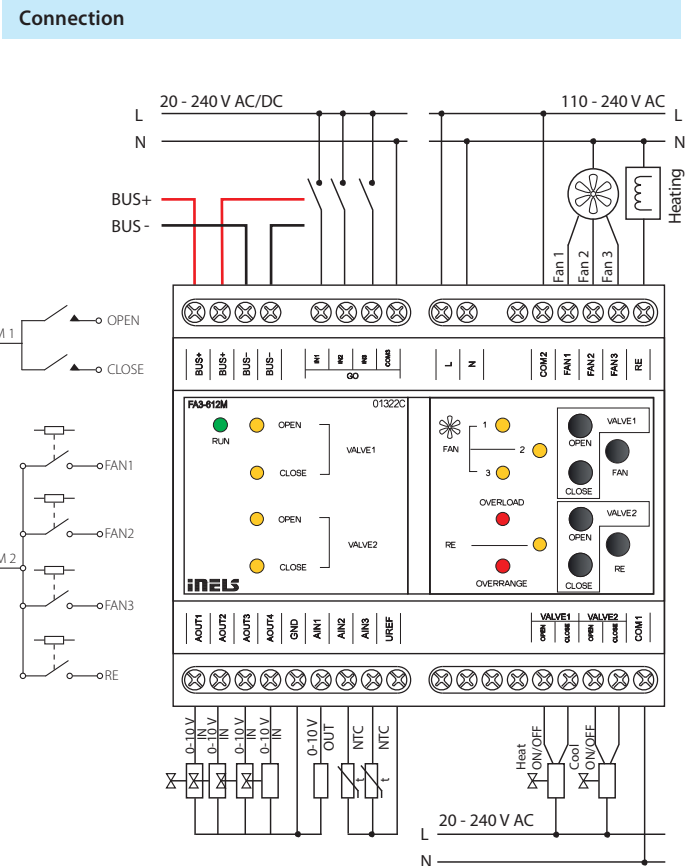

\* selectable for each input individually by configuration in the user program iDM3.  
 \*\* The FA3-612M / Pt version is available for these sensors.

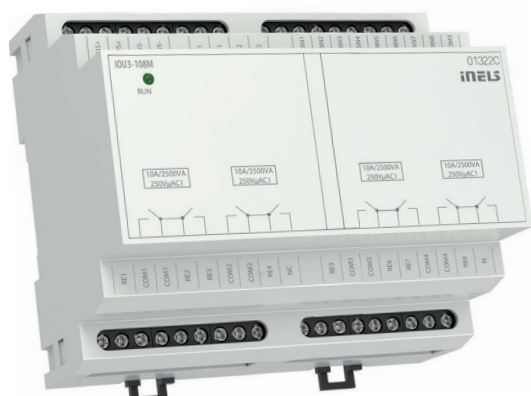

EAN code  
IOU3-108M: 8595188181884  
Order Code: 8188

Technical parameters	IOU3-108M
<b>Outputs</b>	
Output:	8x switching 8 A/AC1
Switched voltage:	250 V AC1, 150 W/DC
Switched output:	2500 VA/AC1, 150 W/DC
Peak current:	10 A
Output relays separated from all internal circuits:	reinforced insulation (Cat. II surges by EN 60664-1)
Isolation between relay outputs COM1, COM2 and COM3:	basic insulation (Cat. II surges by EN 60664-1)
Isolates. voltage open relay contact:	1 kV
Max. current of one common terminal:	16 A
Minimal switched current:	100 mA/10 V DC
Switching frequency without load:	300 min <sup>-1</sup>
Switching frequency with rated load:	15 min <sup>-1</sup>
Mechanical life:	10 000 000
Electrical life AC1:	100 000
Mains voltage detection:	yes - (relay switched to neutral)
<b>Inputs</b>	
Input:	8x NO or NC against GND (-)
Max. frequency pulse reading:	20 Hz
Temperature input for temperature measuring:	2x input for external thermo sensor TC, TZ (NTC 12k)
Temperature measurement range:	by type of sensor, prob from -40 °C to 125 °C
Converter resolution:	15 bit
<b>Communication</b>	
Installation BUS:	BUS
Status indication unit:	green LED RUN
<b>Power supply</b>	
Voltage of BUS/tolerance/nominal current:	27 V DC, -20/+10 %, 110 mA
Dissipated power:	3 W
<b>Connection</b>	
Terminal:	max. 2.5 mm <sup>2</sup> /1.5 mm <sup>2</sup> with sleeve
<b>Operating conditions</b>	
Operating temperature:	-20 to +55 °C
Storing temperature:	-30 to +70 °C
Protection degree:	IP20 device, IP40 mounting in the switchboard
Overvoltage category:	II.
Pollution degree:	2
Operating position:	any
Installation:	switchboard on DIN rail EN 60715
Design:	6-MODULE
<b>Dimensions and weight</b>	
Dimensions:	90 x 105 x 65 mm
Weight:	310 g
Standards:	EN 63044-1

- IOU3-108M is combined actuator equipped with 8 binary inputs, 2 temperature inputs and 8 independent relays with switching potential-free contacts.
- Binary inputs IOU3-108M are used to connect up to 8 devices with a potential-free contact (such as switches, buttons, burglar alarm and fire detectors or others).
- The unit can be used to read pulses from energy meters with a pulse output.
- The temperature inputs support the connection of the following temperature sensors: TC / TZ - 2-wire connection.
- They are used in cases where it is necessary to measure the temperature, eg floor/space, indoor/outdoor temperature, technological equipment - boiler rooms, solar heating, etc.
- The maximum load capacity of the contacts is 10 A / 2500 VA / AC1.
- Each of the output is individually controllable and addressable.
- The relays are divided into four pairs, where each pair switches its common potential.
- The actuator is designed for switching up to eight different appliances and loads via a relay output (potential-free contact).
- IOU3-108M in 6-MODULE design is designed for mounting in a switchboard on DIN rail EN60715.

### Connection

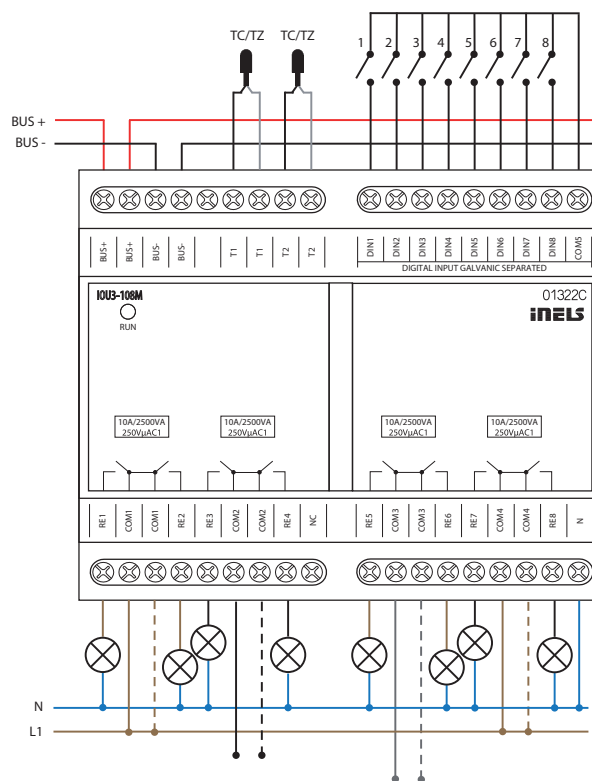

### Diagram

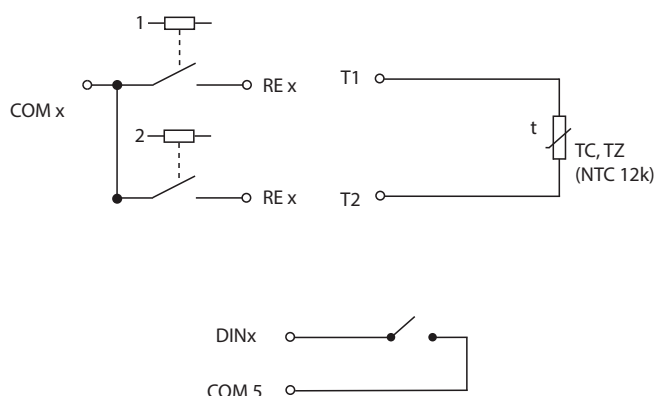

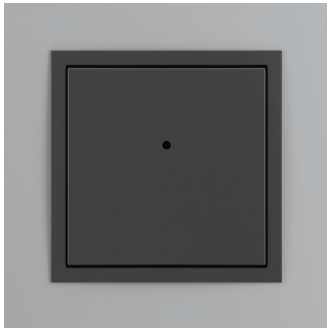

EAN code  
WSB3-20: 8595188132343  
WSB3-20H: 8595188132473

Order Code:  
WSB3-20: 3234  
WSB3-20H: 3247

Technical parameters	WSB3-20	WSB3-20H
<b>Inputs</b>		
Temperature measuring:	yes, built-in temperature sensor	
Scope and accuracy of temp. measuring:	0 to +55 °C; 0.3 °C from the range	
Number of control buttons:	2	
Humidity measurement:	NO	YES
Humidity measurement range:	-	0 to 99 % Relative humidity
Humidity measurement accuracy:	-	± 3 % Relative humidity
Inputs:	2x AIN/DIN	
External temperature sensor:	YES, the connection between AIN1/DIN1 and AIN2/DIN2	
Type of ext. sensor:	TC/TZ	
Temperature measurement range:	-20 °C to +120 °C	
Temp. measurement accuracy:	0.5 °C from range	
<b>Outputs</b>		
Indication:	two-colored LED (red, green)	
Number of LEDs:	1	
<b>Communication</b>		
Installation BUS:	BUS	
<b>Power supply</b>		
Supply voltage/tolerance:	27 V DC, -20/+10 %	
Dissipated power:	max. 0.5 W	
Rated current:	25 mA (at 27 V DC), from BUS	
<b>Connection</b>		
Terminals:	0.5 - 1 mm <sup>2</sup>	
<b>Operating conditions</b>		
Operating temperature:	-20 to +55 °C	
Storing temperature:	-30 to +70 °C	
Protection degree:	IP20	
Overvoltage category:	II.	
Pollution degree:	2	
Operation position:	any	
Installation:	into installation box	
<b>Dimensions and weight</b>		
Dimensions		
- plastic:	85.6 x 85.6 x 42 mm	
- metal, glass, wood, granite:	94 x 94 x 36 mm	
Weight:	55 g (without frame)	
Standards:	EN 63044-1	

- Wall controllers with low-upstroke control WSB3-20 and WSB3-20H are the main and most frequently used units (controller) in the iNELS system.
- Built-in micro-buttons with low upstroke offer elegant and easy controlling.
- Wall switches WSB3-20 and WSB3-20H are available in 2-channels version.
- Double color (red/green) LED diode indicates either status of controlled appliances or status of any sensor or actuator in the system.
- Wall buttons in WSB3 series are compatible with both types of frames LOGUS<sup>90</sup> (85.6 x 85.6 or 94 x 94 mm), therefore you can combine them with double and triple frames and classic products of the series.
- Each controller is equipped with a temperature sensor. It is also equipped with two analog/digital inputs (AIN/DIN), which can be used to connect two potentialless contacts or one external temperature sensor TC/TZ (e.g. for measuring floor temperature).
- Wall button WSB3-20H is comparable to the WSB3-20 but additionally equipped with a relative humidity meter, and for better access of air to the sensor can be used with 99621T including accessories 99622 (Vista MT) and 99,623 (Vista IRMT), instead of the housing cover 99601T.
- Compared to standard wall buttons WSB3-20 and WSB3-20H are more flexible and multifunctional. You can for example controll appliances by short and long push of the button (e.g.: dimming, shutter control, scenes).
- Each button can control any appliance in the system and can use a variety of centralized or time controlled features. Accordingly, the customer can choose the simplicity/complexity of the operation. The big advantage is the possibility to change the method of control by only making software modifications without physical interventions into the structure of the building.
- Each button (fold) can have different functional modes beside lighting control:
  - a) Classic wall-switch:
    - upper button ON, bottom button OFF
  - b) Button controller (impulse relay):
    - first press ON, second press OFF
  - c) Dimmer:
    - short press – ON/OFF
  - d) Time switch:
    - ON after press, automatically OFF after set time
  - e) Setting light scenes – for example: for watching TV:
    - shutters down
    - main light 30% intensity
    - wall-lamps 50% intensity
- WSB3 in LOGUS<sup>90</sup> design is designed for mounting into an installation box.

Connection

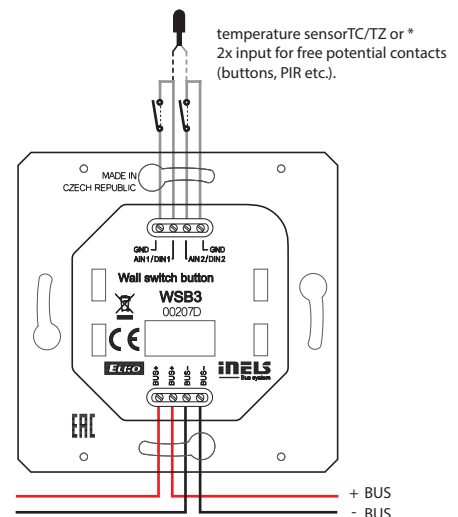

\* The choice is made in iDM3 for each unit separately.

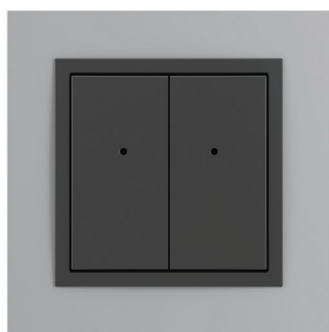

EAN code  
WSB3-40: 8595188132336  
WSB3-40H: 8595188133043

Order Code:  
WSB3-40: 3233  
WSB3-40H: 3304

Technical parameters	WSB3-40	WSB3-40H
<b>Inputs</b>		
Temperature measuring:	YES, built-in temperature sensor	
Scope and accuracy of temp. measuring:	0 to +55 °C ; 0.3 °C from the range	
Number of control buttons:	4	
Humidity measurement:	NO	YES
Humidity measurement range:	-	0 to 99 % Relative humidity
Humidity measurement accuracy:	-	± 3 % Relative humidity
Inputs:	2x AIN/DIN	
External temperature sensor:	YES, the connection between AIN1/DIN1 and AIN2/DIN2	
Type of external sensor:	TC/TZ	
Temp. measurement range:	-20 °C to +120 °C	
Temp. measurement accuracy:	0.5 °C from range	
<b>Outputs</b>		
Indication:	two-colored LED (red, green)	
Number of LEDs:	2	
<b>Communication</b>		
Installation BUS:	BUS	
<b>Power supply</b>		
Supply voltage/tolerance:	27 V DC, -20/+10 %	
Dissipated power:	max. 0.5 W	
Rated current:	25 mA (at 27 V DC), from BUS	
<b>Connection</b>		
Terminals:	0.5 - 1 mm <sup>2</sup>	
<b>Operating conditions</b>		
Operating temperature:	-20 to +55 °C	
Storing temperature:	-30 to +70 °C	
Protection degree:	IP20	
Overvoltage category:	II.	
Pollution degree:	2	
Operation position:	any	
Installation:	into installation box	
<b>Dimensions and weight</b>		
Dimensions		
- plastic:	85.6 x 85.6 x 42 mm	
- metal, glass, wood, granite:	94 x 94 x 36 mm	
Weight:	55 g (without frame)	
Standards:	EN 63044-1	

\* The choice is made in iDM3 for each unit separately.

- Wall mounted controllers with upstroke control WSB3-40 and WSB3-40H are the basic and most popular feature (control) of the iNELS system.
- Built-in micro-switch with low upstroke offers elegant and pleasant control.
- Controllers WSB3-40 and WSB3-40H are supplied with 4-channels.
- Two-coloured indication LEDs located in each controller, can signal the status of controlled appliances or the status of any sensor or actuator in the system.
- Wall buttons in WSB3 series are compatible with both types of frames LOGUS<sup>90</sup> (85.6x85.6 or 94x94 mm), therefore you can combine them with double and triple frames and classic products of the series.
- Each controller is equipped with a temperature sensor. It is also equipped with two analog/digital inputs (AIN/DIN), which can be used to connect two potentialless contacts or one external temperature sensor TC/TZ (e.g. for measuring floor temperature).
- Compared to standard wall buttons WSB3-20 and WSB3-20H are more flexible and multifunctional. You can for example controll appliances by short and long push of the button (e.g.: dimming, shutter control, scenes).
- Each button can control any appliance in the system and can use a variety of centralized or time controlled features. Accordingly, the customer can choose the simplicity/complexity of the operation. The big advantage is the possibility to change the method of control by only making software modifications without physical interventions into the structure of the building.
- Each button (fold) can have different functional modes beside lighting control:
  - a) Classic wall-switch:
    - upper button ON, bottom button OFF
  - b) Button controller (impulse relay):
    - first press ON, second press OFF
  - c) Dimmer:
    - short press – ON/OFF
  - d) Time switch:
    - ON after press, automatically OFF after set time
  - e) Setting light scenes – for example: for watching TV:
    - shutters down
    - main light 30% intensity
    - wall-lamps 50% intensity
- WSB3 in LOGUS<sup>90</sup> design is designed for mounting into an installation box.

## Connection

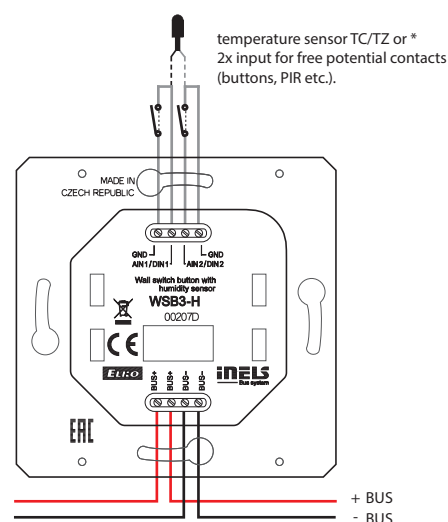



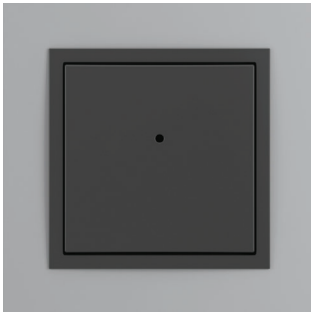

EAN code  
WMR3-21: 8595188132756  
Order Code: 3275

Technical parameters		WMR3-21
<b>Inputs</b>		
Number of control buttons:	2	
<b>RFID readers</b>		
Supported frequencies:	13.56 MHz	
Card Type:	MIFARE Ultralight, DESFire 2K (EV1), DESFire 4K (EV1)	
<b>Outputs</b>		
Output:	1x changeover 8 A/AgSnO <sub>2</sub>	
Indication:	two-color LED (red, green)	
Acoustic output:	piezo-changer	
Switching voltage:	230 V A/30 V DC	
Switching output:	2000 VA/AC1; 240 W/DC	
Peak current:	20 A/<3s	
Insulation voltage between relay outputs and internal circuits:	3.75 kV, SELV according to EN 60950	
Minimal switched current:	10 mA/10 V	
Switching frequency without load:	300 min <sup>-1</sup>	
Switching frequency with rated load:	15 min <sup>-1</sup>	
Mechanical life:	1x 10 <sup>7</sup>	
Electrical life AC1:	1x 10 <sup>5</sup>	
<b>Communication</b>		
Installation BUS:	BUS	
<b>Power supply</b>		
Supply voltage/tolerance:	27 V DC, -20/+10 %	
Dissipated power:	max. 0.5 W	
Rated current:	50 mA (at 27 V DC), from BUS	
<b>Connection</b>		
Data:	terminals, 0.5 - 1 mm <sup>2</sup>	
Network:	max. 2.5 mm <sup>2</sup> /1.5 mm <sup>2</sup> with sleeve	
<b>Operating conditions</b>		
Operating temperature:	-20 to +55 °C	
Storing temperature:	-30 to +70 °C	
Protection degree:	IP20	
Overvoltage category:	II.	
Pollution degree:	2	
Operation position:	any	
Installation:	into installation box	
<b>Dimensions and weight</b>		
Dimensions		
- plastic:	85.6 x 85.6 x 42 mm	
- metal, glass, wood, granite:	94 x 94 x 36 mm	
Weight:	68 g (without frame)	
Standards:	EN 63044-1	

- WMR3-21 is a wall-mounted card reader that is designed to read contactless media (smart cards, key chains, etc.), which are used for controlling access to buildings or their parts.
- With the glass controller WMR3-21 users will appreciate the ease of control using two push buttons, which can be assigned different control functions (lighting, shading, scenes, heating, etc.).
- WMR3-21 reader can be used to control the security system (locking/unlocking) access system (opening doors, gates, etc.) or appliances (based on assigned rights).
- WMR3-21 supports RFID media with the carrier frequency of 13.56 MHz. Supported card types MIFARE Ultralight, DESFire 2K (EV1), DESFire 4K (EV1).
- WMR3-21 is also equipped with 8 A relay output with changeover contact AgSnO<sub>2</sub>, by which controlled devices can be switched directly (or any actuator in the system can be set in software iDM3).
- Indication two-color LED in the controller cover can indicate not only the status of controlled appliance, but also the status of any sensor or actuator in the system.
- Wall card reader WMR3-21 is compatible with both types of frames LOGUS<sup>90</sup> (85.6 x 85.6 or 94 x 94 mm), therefore you can combine them with double and triple frames and classic products of the series.

Connection

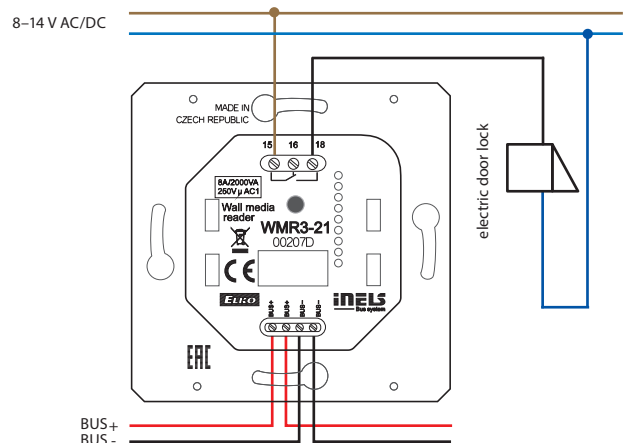



EAN code	Order Code:
GCR3-30/B: 8595188191692	GCR3-30/B: 9169
GCR3-30/W: 8595188191708	GCR3-30/W: 9170
GCR3-230/B: 8595188191715	GCR3-230/B: 9171
GCR3-230/W: 8595188191722	GCR3-230/W: 9172

Technical parameters	GCR3-30	GCR3-230
<b>Inputs</b>		
Illuminance sensor:	1 to 100 000 Lx	
Proximity Sensor:	(SWP/SBP models) motion detection at a distance of 0.25 m	
<b>RFID readers</b>		
Supported frequencies:	13.56 MHz	
Card Type:	Mifare 1k, 4k, Ultralight, DesFire, ISO/IEC 14443-4 (CD97BX, CD light, P5CN072 (SMX) Innovision jewel (IRT5001), FeliCa (RCS_860, RCS_854)	
<b>Buttons</b>		
Number of control buttons:	3	
Type:	capacitive	
Indication:	coloured illuminated symbol	
<b>Outputs</b>		
Acoustic output:	piezo-changer	
<b>Communication</b>		
Installation BUS:	BUS	
<b>Power supply</b>		
Supply voltage/tolerance:	27 V DC, -20/+10 %	
Dissipated power:	max. 0.5 W	
Rated current:	25-50 mA (at 27 V DC), from BUS	
<b>Connection</b>		
Terminals:	EIB $\varnothing$ 0.6 - 0.8 mm <sup>2</sup>	
<b>Operating conditions</b>		
Relative humidity:	max. 80 %	
Operating temperature:	-20 to +55 °C	
Storing temperature:	-30 to +70 °C	
Protection degree:	IP20	
Overvoltage category:	II.	
Pollution degree:	2	
Operation position:	any	
Installation:	on the wall, observing the conditions for correct installation of the sensor	
<b>Dimensions and weight</b>		
Dimensions:	94 x 94 x 41 mm   100 x 100 x 8 mm	
Weight:	154 g	
Standards:	EN 63044-1	

- Glass card reader GCR3-30 is part of a comprehensive range of glass iNELS control units and can be advantageously used in all projects, e.g. guest room management system (GRMS).
- GCR3-30 card reader is designed for reading smart cards, which are intended to enter the hotel room or any other part of the building.
- GCR3-30 supports RFID media with a carrier frequency of 13.56 MHz. Supported card types Mifare 1k, 4k, Ultralight, DesFire, ISO/IEC 14443-4 (CD97BX, CD light, P5CN072 (SMX) Innovision jewel (IRT5001), FeliCa (RCS\_860, RCS\_854)
- The GCR3 is a design component of the iNELS system and is available in elegant black (GCR3-30/B, GCR3-230/B) and white (GCR3-30/W, GCR3-230/W) variants. The GCR3-30 models feature a square design, while the GCR3-230 models come in a round design.
- Engraving of symbols is possible upon a request. The room number as well as the logo of the hotel can be also engraved on each component.
- The controller is also equipped with 3x capacitive touch button with different function or macro (set of functions). It is therefore possible to use one button to control several application. For eg. Function of bell and with two icons to indicate the status of guest requests, e.g. "Do Not Disturb" and "Make Up Room", whose state guest can set from other glass switch panel.
- Individual symbols can be illuminated in one of seven colours - red, green, blue, yellow, pink, turquoise and white.
- Reader GCR3-30 is equipped with a sensor for ambient light intensity and proximity sensor. Based on information from the sensor it can e.g. switch the lighting circuits in the corridor.
- All versions are in the size of the standard module (94x94 mm) and are designed for mounting into an installation.
- GCR3-30 are designed for mounting into an installation box.

### Instrument description

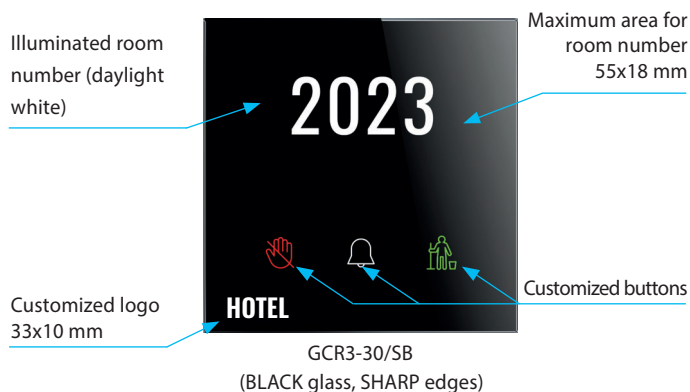

### Button legend

Create your glass design here:  
[icons.inels.com](https://icons.inels.com)



### Connection

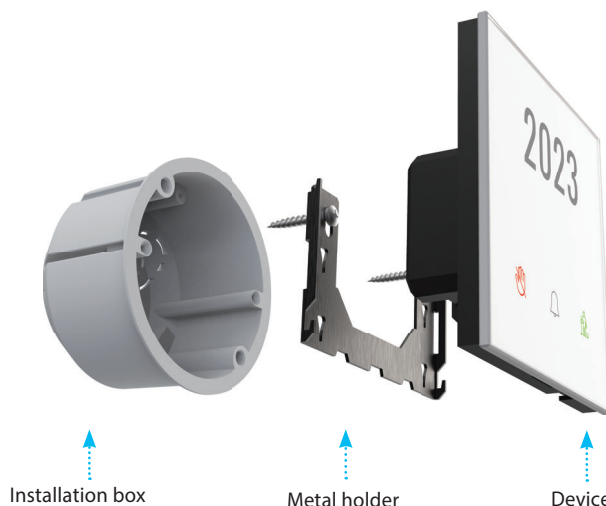



N

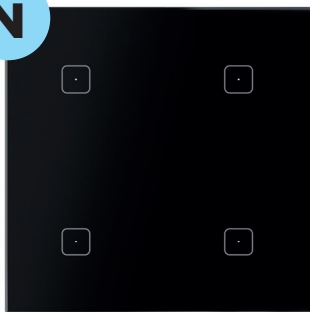

EAN code  
GSB3-40/B\_V2: 8595188132909  
Order Code: 3290

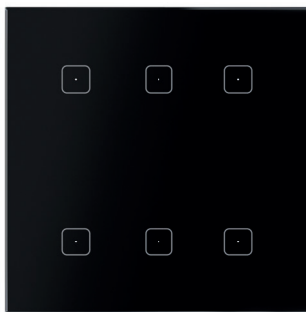

EAN code  
GSB3-60/B\_V2: 8595188132916  
Order Code: 3291



EAN code  
GSB3-90/B\_V2: 8595188188272  
Order Code: 8827

## Technical parameters

### GSB3-XX, GSB3-2XX

#### Inputs

Temperature measuring:	YES, built-in temperature sensor
Scope and accuracy of temp. measurement:	0 to +55 °C; 0.3 °C from the range
Humidity measurement:	YES
Humidity measurement range:	0 to 99 % RH
Inputs:	AIN/DIN
Resolution:	by setting 10-bit
External temperature sensor:	YES, the connection between AIN1/DIN1 and AIN2/DIN2
Type of external sensor:	TC/TZ
Temperature measurement range:	-20 °C to +120 °C
Temperature measurement accuracy:	0.5 °C from the range

#### Buttons

Number of control buttons:	4	6	9
Type:	capacitive		
Indication:	blue highlighted point		

#### Outputs

Acoustic output:	piezo-changer
------------------	---------------

#### Communication

Installation BUS:	BUS
-------------------	-----

#### Power supply

Supply voltage/tolerance:	27 V DC, -20/+10 %		
Dissipated power:	max. 0.5 W		
Rated current:	20-38 mA	20-45 mA	20-50 mA
	(at 27 V DC), from BUS		

#### Connection

Terminals:	EIB $\varnothing$ 0.6 - 0.8 mm <sup>2</sup>
------------	---

#### Operating conditions

Relative humidity:	max. 80 %
Operating temperature:	-20 to +55 °C
Storing temperature:	-30 to +70 °C
Protection degree:	IP20
Overvoltage category:	II.
Pollution degree:	2
Operation position:	any
Installation:	on the wall, observing the conditions for correct installation of the sensor

#### Dimensions and weight

Dimensions:	94 x 94 x 41 mm   100 x 100 x 8 mm
Weight:	154 g
Standards:	EN 63044-1

- Glass touch controllers GSB3-XXX are part of a comprehensive range of glass iNELS control units and can be advantageously used in all projects for example as a part of guest room management system (GRMS).
- The GSB3-40, GSB3-60, and GSB3-90 models feature a square design, while the GSB3-240, GSB3-260, and GSB3-290 models come in a round design.
- GSB3-40, GSB3-240 is equipped with four, GSB3-60, GSB3-260 six and GSB3-90, GSB3-290 nine touch buttons whose functions can easily modify by the software.
- The glass touch controllers is equipped with an integrated temperature sensor. It is also equipped with analog-to-digital input (AIN/DIN), which can be used to connect potential-free contact or external temperature sensor TC/TZ (for example temperature measurement of the floor).
- Advantages over conventional switches/buttons are saving space, signaling the state of any system output, the ability to measure temperature as well as the ability to connect external buttons or detectors.
- Each button can control any actuator (appliance) in the system. Also, you can assign each button a different function or macro (set of functions). It is therefore possible to use one button to control several appliances at once.
- Glass touch panel is a design component of the iNELS system and is available in elegant black (GSB3-XXX/B) and white (GSB3-XXX/W) versions.
- The individual capacitive buttons are point-illuminated by a blue LED indicating the status of the controlled output.
- All versions are in the size of the standard module (94x94 mm) and designed for mounting into an installation box.

#### Another view



GSB3-60B

N

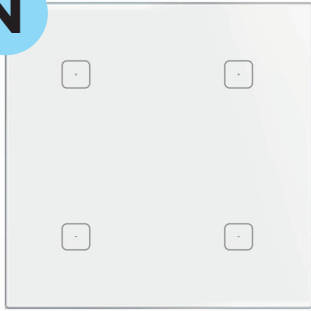

EAN code  
GSB3-40/W\_V2: 8595188132954  
Order Code: 3295



EAN code  
GSB3-60/W\_V2: 8595188132985  
Order Code: 3298



EAN code  
GSB3-90/W\_V2: 8595188188289  
Order Code: 8828

N

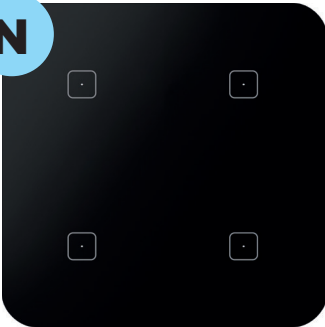

EAN code  
GSB3-240/B: 8595188189569  
Order Code: 8956



EAN code  
GSB3-260/B: 8595188189583  
Order Code: 8958

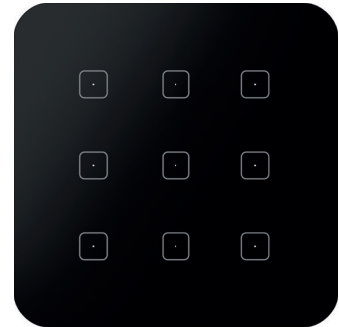

EAN code  
GSB3-290/B: 8595188189606  
Order Code: 8960

N

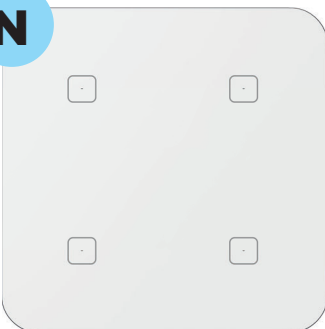

EAN code  
GSB3-240/W: 8595188189576  
Order Code: 8957

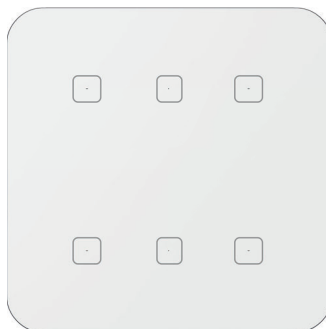

EAN code  
GSB3-260/W: 8595188189590  
Order Code: 8959

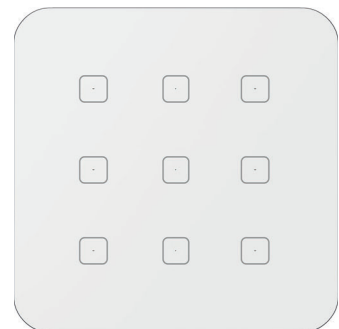

EAN code  
GSB3-290/W: 8595188189613  
Order Code: 8961

Connection

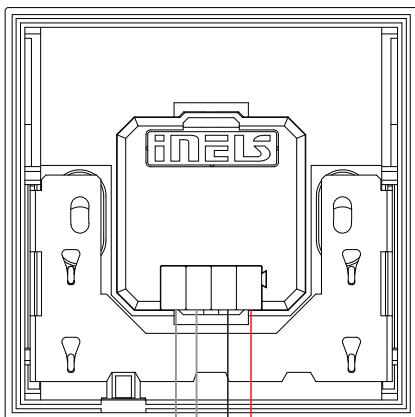

1x input for free potential contacts  
(button, motion sensor, etc.)

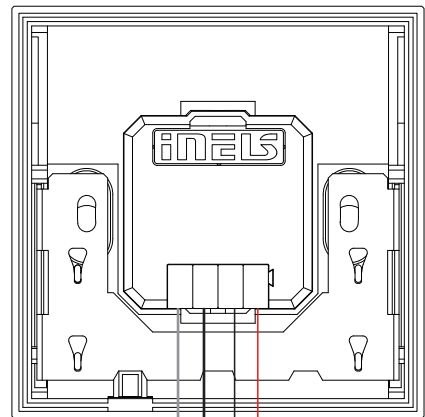

temperature sensor TC/TZ



N

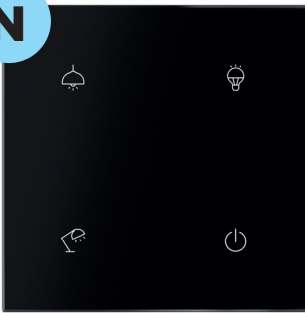

EAN code  
GSB3-40/SB\_V2: 8595188156233  
GSB3-40/SBP\_V2: 8595188188883 (proximity)  
Order code  
GSB3-40/SB\_V2: 8875  
GSB3-40/SBP\_V2: 8888 (proximity)

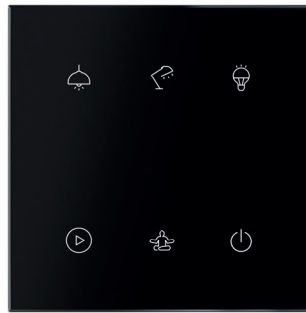

EAN code  
GSB3-60/SB\_V2: 8595188156257  
GSB3-60/SBP\_V2: 8595188188869 (proximity)  
Order code  
GSB3-60/SB\_V2: 8873  
GSB3-60/SBP\_V2: 8886 (proximity)



EAN code  
GSB3-90/SB\_V2: 8595188188258  
GSB3-90/SBP\_V2: 8595188188845 (proximity)  
Order code  
GSB3-90/SB\_V2: 8825  
GSB3-90/SBP\_V2: 8884 (proximity)

## Technical parameters GSB3-XX/S, GSB3-2XX/S

### Inputs

Temperature measuring:	YES, built-in temperature sensor
Scope and accuracy of temp. measurement:	0 to +55 °C; 0.3 °C from the range
Humidity measurement:	YES
Humidity measurement range:	0 to 99 % RH
Inputs:	AIN/DIN
Resolution:	by setting 10-bit
External temperature sensor:	YES, the connection between AIN1/DIN1 and AIN2/DIN2
Type of external sensor:	TC/TZ
Temperature measurement range:	-20 °C to +120 °C
Temperature measurement accuracy:	0.5 °C from the range
Illuminance sensor:	1 to 100 000 Lx
Proximity Sensor:	(SWP/SBP models) motion detection at a distance of 0.25 m

### Buttons

Number of control buttons:	4	6	9
Type:	capacitive		
Indication:	coloured illuminated symbol		

### Outputs

Acoustic output:	piezo-changer
------------------	---------------

### Communication

Installation BUS:	BUS
-------------------	-----

### Power supply

Supply voltage/tolerance:	27 V DC, -20/+10 %		
Dissipated power:	max. 0.5 W		
Rated current:	25-43 mA	25-50 mA	25-50 mA
	(at 27 V DC), from BUS		

### Connection

Terminals:	EIB $\varnothing$ 0.6 - 0.8 mm <sup>2</sup>
------------	---

### Operating conditions

Relative humidity:	max. 80 %
Operating temperature:	-20 to +55 °C
Storing temperature:	-30 to +70 °C
Protection degree:	IP20
Overvoltage category:	II.
Pollution degree:	2
Operation position:	any
Installation:	on the wall, observing the conditions for correct installation of the sensor

### Dimensions and weight

Dimensions:	94 x 94 x 41 mm   100 x 100 x 8 mm
Weight:	154 g
Standards:	EN 63044-1

- Glass touch controllers with symbols GSB3-XX/S are part of a comprehensive range of glass iNELS control units and can be advantageously used in all projects for example as a part of guest room management system (GRMS).
- The GSB3-40/S, GSB3-60/S, and GSB3-90/S models feature a square design, while the GSB3-240/S, GSB3-260/S, and GSB3-290/S models come in a round design.
- GSB3-40/S, GSB3-240/S is equipped with four, GSB3-60/S, GSB3-260/S six and GSB3-90/S, GSB3-290/S nine touch buttons whose functions can easily modify by the software.
- Symbols on the glass touch controllers can be engraved upon request, allowing for personalized and tailored solutions to meet specific project needs. Additionally, there is an option to engrave text for each button, further enhancing customization possibilities.
- The glass touch controllers is equipped with an integrated temperature sensor. It is also equipped with analog-to-digital input (AIN/DIN), which can be used to connect potential-free contact or external temperature sensor TC/TZ (for example temperature measurement of the floor).
- Advantages over conventional switches/buttons are saving space, signalling the state of any system output, the ability to measure temperature as well as the ability to connect external buttons or detectors.
- Each button can control any actuator (appliance) in the system. Also, you can assign each button a different function or macro (set of functions). It is therefore possible to use one button to control several appliances at once.
- Glass touch panel is a design component of the iNELS system and is available in elegant black (GSB3-XXX/SB) and white (GSB3-XXX/SW) versions.
- Individual symbols can be illuminated in one of seven colours - red, green, blue, yellow, pink, turquoise and white.
- All versions are in the size of the standard module (94x94 mm) and are designed for mounting into an installation box.
- In addition to all the features in symbol models. The glass touch controllers in the SBP/SWP version are equipped with a proximity sensor, which can light up the symbols by approaching the unit to approx. 0.25 m.
- SWP/SBP models are also equipped with a sensor of ambient light intensity. Based on information from the sensor it can switch backlight of symbols or perform various actions in the iDM3 software, for example also switch the lighting circuits in the room.

### Another view



GSB3-260SW



**N**

EAN code  
GSB3-40/SW\_V2: 8595188156240  
GSB3-40/SWP\_V2: 8595188188890 (proximity)  
Order code  
GSB3-40/SW\_V2: 8876  
GSB3-40/SWP\_V2: 8889 (proximity)

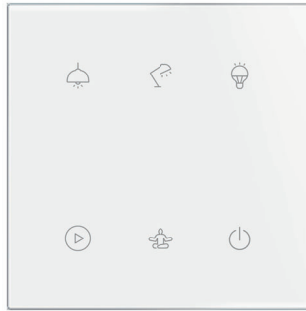

EAN code  
GSB3-60/SW\_V2: 8595188156264  
GSB3-60/SWP\_V2: 8595188188876 (proximity)  
Order code  
GSB3-60/SW\_V2: 8874  
GSB3-60/SWP\_V2: 8887 (proximity)

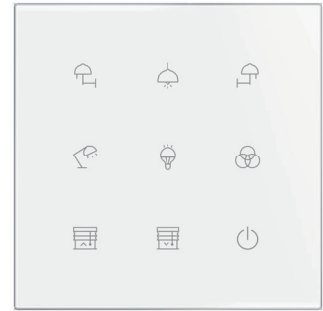

EAN code  
GSB3-90/SW\_V2: 8595188188265  
GSB3-90/SWP\_V2: 8595188188852 (proximity)  
Order Code:  
GSB3-90/SW\_V2: 8826  
GSB3-90/SWP\_V2: 8885



**N**

EAN code  
GSB3-240/SB: 8595188189620  
GSB3-240/SBP: 8595188189682 (proximity)  
Order code  
GSB3-240/SB: 8962  
GSB3-240/SBP: 8968 (proximity)



EAN code  
GSB3-260/SB: 8595188189644  
GSB3-260/SBP: 8595188189705 (proximity)  
Order code  
GSB3-260/SB: 8964  
GSB3-260/SBP: 8970 (proximity)



EAN code  
GSB3-290/SB: 8595188189668  
GSB3-290/SBP: 8595188189729 (proximity)  
Order Code:  
GSB3-290/SB: 8966  
GSB3-290/SBP: 8972 (proximity)

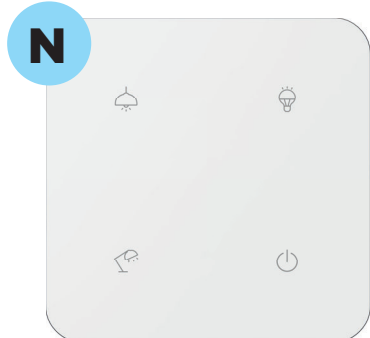

**N**

EAN code  
GSB3-240/SW: 8595188189637  
GSB3-240/SWP: 8595188189699 (proximity)  
Order code  
GSB3-240/SW: 8963  
GSB3-240/SWP: 8969 (proximity)



EAN code  
GSB3-260/SW: 8595188189651  
GSB3-260/SWP: 8595188189712 (proximity)  
Order code  
GSB3-260/SW: 8965  
GSB3-260/SWP: 8971 (proximity)



EAN code  
GSB3-290/SW: 8595188189675  
GSB3-290/SWP: 8595188189736 (proximity)  
Order Code:  
GSB3-290/SW: 8967  
GSB3-290/SWP: 8973 (proximity)

The picture of device is illustrative, the icons (symbols) are configurable by the customer.

Connection

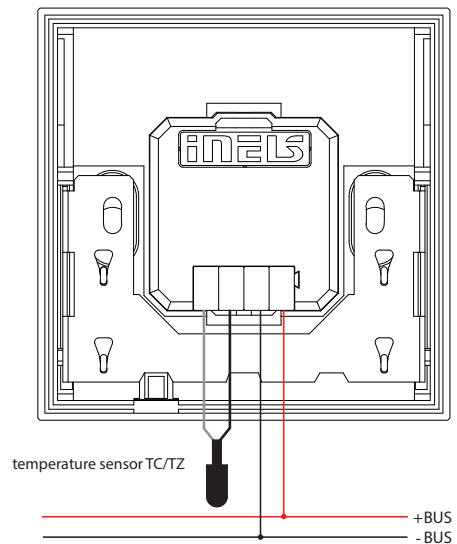
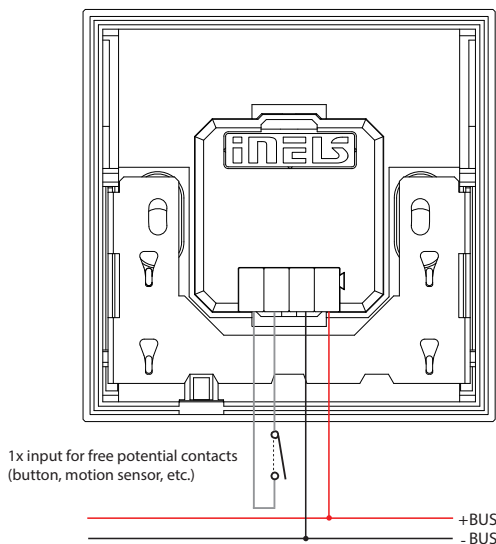

The Icon Configurator for iNELS controllers is a software tool that allows users to customise and personalise the icons used on their iNELS controllers. With this tool, users can choose from a variety of pre-designed icons to suit their specific needs. The Icon Configurator is a powerful tool that gives users complete control over the look and feel of their iNELS control systems, allowing them to create a truly unique and customised user experience.

### The features and benefits of the iNELS Icon Configurator for controllers

The iNELS Icon Configurator for controllers offers a range of features that allow for a highly customized user interface. With this tool, users can create personalized icon control buttons in just a few minutes, enabling the creation of good-looking UI's with minimal effort. This customization capability allows for a more tailored user experience, as the interface can be designed to meet the specific needs of the user or application. With the ability to customize the user interface, users can create a control system that is both functional and aesthetically pleasing. One of the key benefits of the configurator is its easy and intuitive configuration process. This intuitive interface makes it easy for users to configure the system without the need for extensive technical knowledge or training.

#### Choice controller

In the first step, select the driver variant.

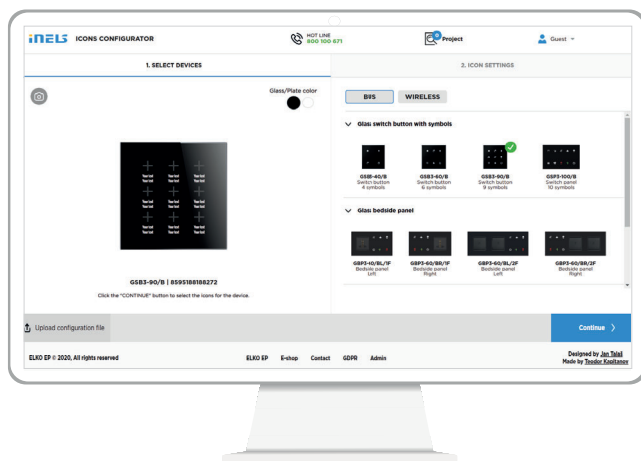

#### Icons settings

In the second step, we will be shown the quantity that we can use.

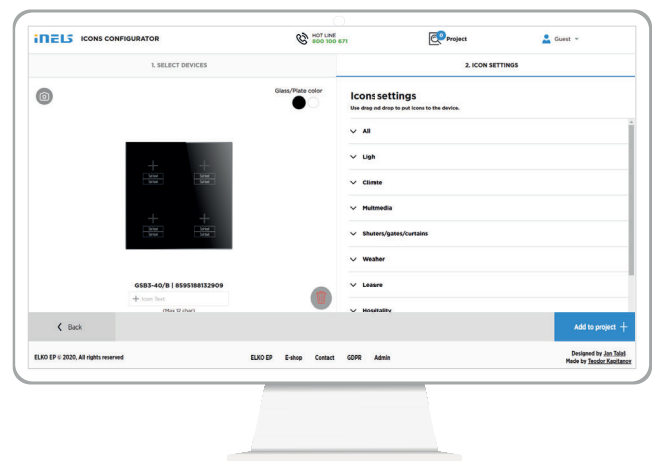

#### Choice icons

In the third step, you place the icons on the controller according to your preferences.

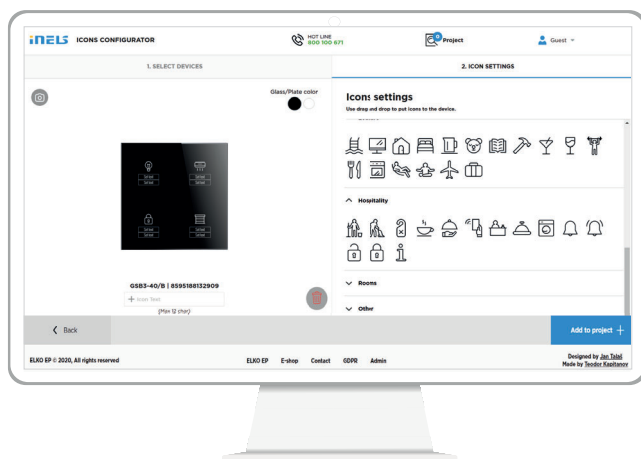

#### Icon name

In the last step, we can choose any name we want under the icon on the controller.

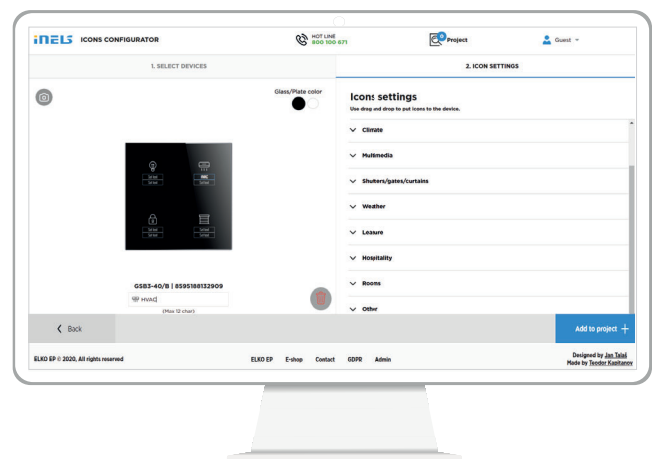

Create your glass design here:  
[icons.inels.com](https://icons.inels.com)



Standard symbols for laser on plastic key and glass panel

	A	B	C	D	E	F	G	H	I	J	K	L
1										ON	OFF	
2												
3												
4									AUTO			
5												
6												
7												
8												
9												
10												
11												
12												
13												
14												
15												
16										ECO		

N

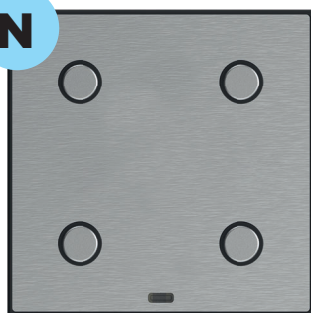

EAN code  
MSB3-40SS: 8595188191364  
Order Code: 9136

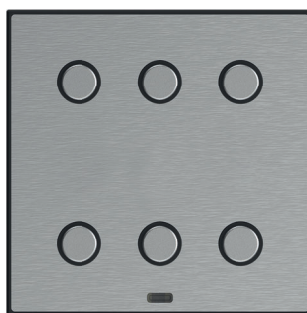

EAN code  
MSB3-60SS: 8595188191449  
Order Code: 9144

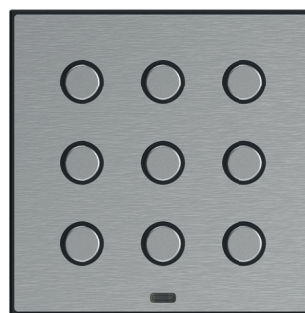

EAN code  
MSB3-90SS: 8595188189460  
Order Code: 8946

Technical parameters	MSB3-40	MSB3-60	MSB3-90
<b>Inputs</b>			
Temperature measuring:	YES, built-in temperature sensor		
Scope and accuracy of temp. measurement:	0 to +55 °C; 0.3 °C from the range		
Humidity measurement:	YES		
Humidity measurement range:	0 to 99 % RH		
Inputs:	AIN/DIN		
External temperature sensor:	YES, the connection between AIN1/DIN1 and AIN2/DIN2		
Type of external sensor:	TC/TZ		
Temperature measurement range:	-20 °C to +120 °C		
Temperature measurement accuracy:	0.5 °C from the range		
Illuminance sensor:	1 to 12 000 Lx		
<b>Buttons</b>			
Number of control buttons:	4	6	9
Type:	button		
Indication:	white illuminated button		
<b>Outputs</b>			
Acoustic output:	piezo-changer		
<b>Communication</b>			
Installation BUS:	BUS		
<b>Power supply</b>			
Supply voltage/tolerance:	27 V DC, -20/+10 %		
Dissipated power:	max. 0.5 W		
Rated current:	25-43 mA	25-50 mA	25-50 mA
	(at 27 V DC), from BUS		
<b>Connection</b>			
Terminals:	EIB $\varnothing$ 0.6 - 0.8 mm <sup>2</sup>		
<b>Operating conditions</b>			
Relative humidity:	max. 80 %		
Operating temperature:	-20 to +55 °C		
Storing temperature:	-30 to +70 °C		
Protection degree:	IP40		
Overvoltage category:	II.		
Pollution degree:	2		
Operation position:	any		
Installation:	on the wall, observing the conditions for correct installation of the sensor		
<b>Dimensions and weight</b>			
Dimensions:	94 x 94 x 40 mm		
Weight:	154 g		
Standards:	EN 63044-1		
<b>Example</b>			

- MSB3- XX/BB = Graphite black plate + Graphite black button
- MSB3- XX/GG = Satin brass plate + Satin Brass button
- MSB3- XX/SS = Brushed silver plate + Brushed silver button
- MSB3- XX/CC = Antique copper plate + Antique copper button

- Metal switch buttons MSB3-40/XX, MSB3-60/XX and MSB3-90/XX are part of a comprehensive range of iNELS control units and can be advantageously used in all projects.
- MSB3 comes with premium metal plates in the antique copper, satin brass, brushed silver, and graphite black finish.
- MSB3-40/XX is equipped with four, MSB3-60/XX six and MSB3-90/XX nine touch buttons whose functions can easily modify by the software.
- The metal switch button are equipped with an integrated temperature sensor. It is also equipped with analog-to-digital input (AIN/DIN), which can be used to connect potential-free contact or external temperature sensor TC/TZ (for example temperature measurement of the floor).
- Advantages over conventional switches/buttons are saving space, signalling the state of any system output, the ability to measure temperature as well as the ability to connect external buttons or detectors.
- Each button can control any actuator (appliance) in the system. Also, you can assign each button a different function or macro (set of functions). It is therefore possible to use one button to control several appliances at once.
- Metal switch button is a design component of the iNELS system and is available in antique copper, satin brass, brushed silver, and graphite black versions.
- There is an option upon request to engrave text for each button, further enhancing customization possibilities.
- Individual buttons can be illuminated in white.
- MSB3-40/XX, MSB3-60/XX and MSB3-90/XX are designed for mounting into an installation box.
- All versions are in the size of the standard module (94x94 mm).

#### Another view



MSB3-90/CC

N

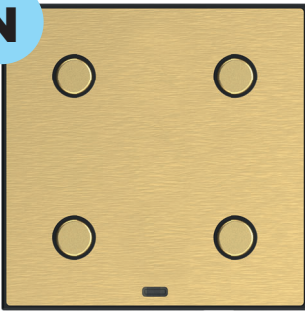

EAN code  
MSB3-40GG: 8595188191388  
Order Code: 9138

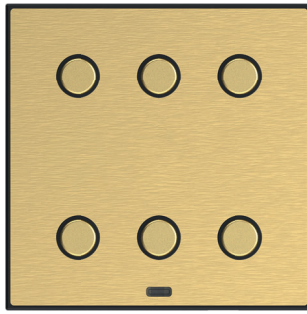

EAN code  
MSB3-60GG: 8595188191463  
Order Code: 9146

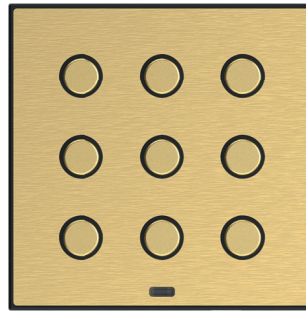

EAN code  
MSB3-90GG: 8595188189088  
Order Code: 8908

N

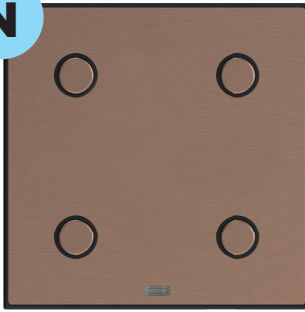

EAN code  
MSB3-40CC: 8595188191401  
Order Code: 9140

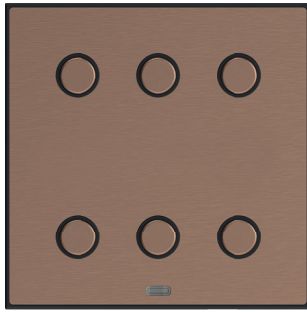

EAN code  
MSB3-60CC: 8595188191487  
Order Code: 9148

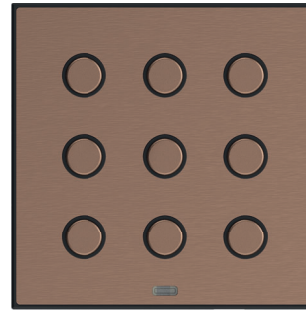

EAN code  
MSB3-90CC: 8595188191319  
Order Code: 9131

N



EAN code  
MSB3-40BB: 8595188191425  
Order Code: 9142



EAN code  
MSB3-60BB: 8595188191500  
Order Code: 9150



EAN code  
MSB3-90BB: 8595188191333  
Order Code: 9133

### MSB3-90/xx

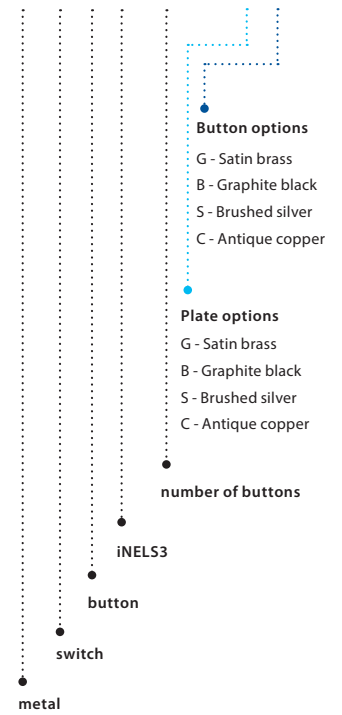

### Connection

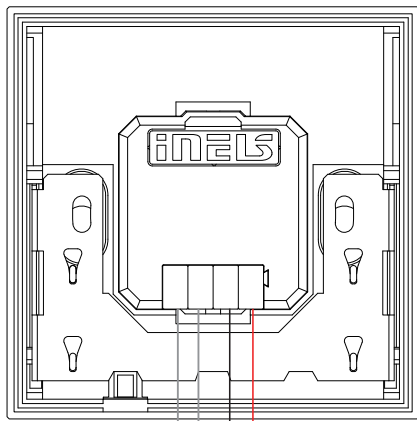

1x input for free potential contacts  
(button, motion sensor, etc.)

+BUS  
-BUS

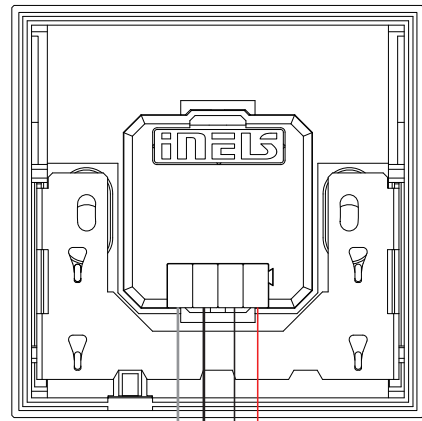

temperature sensor TC/TZ

+BUS  
-BUS



## EAN code

IDRT3-1 white:	8595188149488 (device, cover)
IDRT3-1 ivory:	8595188179614 (device, cover)
IDRT3-1 ice:	8595188179591 (device, cover)
IDRT3-1 pearl:	8595188179621 (device, cover)
IDRT3-1 aluminium:	8595188179584 (device, cover)
IDRT3-1 gray:	8595188179607 (device, cover)

## Technical parameters

## IDRT3-1

## Inputs

Temperature measuring:	YES, built-in thermo sensor
Range/accuracy of temp. measuring:	0 to +55 °C; 0.3 °C from range
Heating/cooling circuit correction:	±3, ±4 or ±5 °C
Manual control of heating/cooling circuit:	2 x buttons
External temperature sensor:	YES, the connection between AIN1/DIN1 and AIN2/DIN2
Type of external sensor:	TC/TZ
Temperature measurement range:	-20 °C to +120 °C
Temperature measurement accuracy:	0.5 °C from range

## Communication

Installation:	BUS
Display:	symbol display
Backlight:	YES

## Power supply

Supply voltage/tolerance:	27 V DC, -20/+10 %
Dissipated power:	max. 0.5 W
Rated current:	20 mA (at 27 V DC), from BUS

## Connection

Terminals:	0.5 - 1 mm <sup>2</sup>
------------	-------------------------

## Operating conditions

Operating temperature:	0 to +50 °C
Protection degree:	IP20
Overvoltage category:	II.
Pollution degree:	2
Operation position:	vertical, downward with BUS terminal
Installation:	into installation box

## Dimensions and weight

Dimensions	
- plastic:	85.6 x 85.6 x 50 mm
- metal, glass, wood, granite:	94 x 94 x 50 mm
Weight:	76 g (without frame)
Standards:	EN 63044-1

- IDRT3-1 is a digital wall temperature controller used to regulate the temperature in a room.
- Using the IDRT3-1, it is possible to correct the given heating/cooling circuit within a range of ±3, ±4 or ±5 °C (optional in SW iDM3).
- The temperature controller is equipped with an integrated heat sensor used to measure the room temperature. It is also equipped with two analog digital inputs (AIN/DIN), which can be used to connect two potential free contacts or a single external temperature sensor TC/TZ (e.g. for measuring the floor temperature).
- The display shows the current temperature and after pressing one of two buttons under the display, you can control the desired temperature.
- Readability improves after pressing one of the buttons to activate the backlight.
- Heating/cooling circuit is assigned with a thermo-regulator using iDM3.
- In the case of temperature correction within ±3, ±4 or ±5 °C, this change is valid until the next time mark within the time schedule established in iDM3.
- IDRT3-1 in design LOGUS<sup>90</sup> is intended for mounting into an installation box.

## Connection

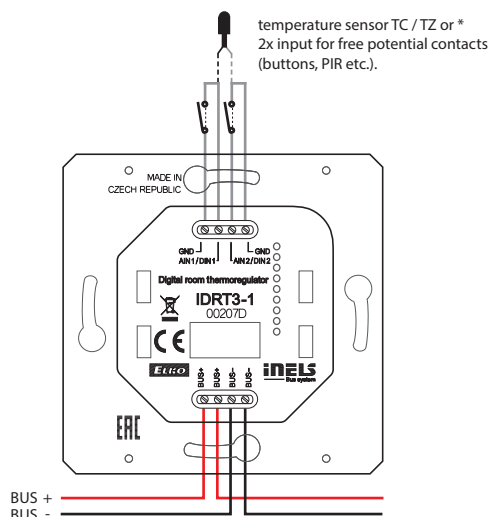

\* The choice is made in iDM3 for each unit separately.

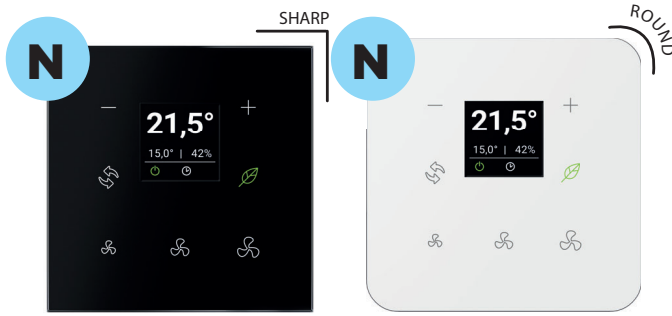

EAN code  
 GRT3-70/B: 8595188191548  
 GRT3-70/W: 8595188191531  
 GRT3-270/B: 8595188191562  
 GRT3-270/W: 8595188191555

Order Code:  
 GRT3-70/B: 9154  
 GRT3-70/W: 9153  
 GRT3-270/B: 9156  
 GRT3-270/W: 9155

The picture of device is illustrative, the icons (symbols) are configurable by the customer.

Technical parameters	GRT3-70	GRT3-270
<b>Inputs</b>		
Temperature measuring:	YES, built-in temperature sensor	
Scope and accuracy of temp. measurement:	0 to +55 °C; 0.3 °C from the range	
Humidity measurement:	YES	
Humidity measurement range:	0 to 99 % RH	
Humidity measurement accuracy:	± 3 % relative humidity	
Inputs:	1x AIN/DIN	
Resolution:	by setting 10-bit	
External temperature sensor:	YES, the connection between AIN1/DIN1 and AIN2/DIN2	
Type of external sensor:	TC/TZ	
Temperature measurement range:	-20 °C to +120 °C	
Temperature measurement accuracy:	0.5 °C from the range	
<b>Buttons</b>		
Number of control buttons:	7	
Type:	capacitive	
Indication:	coloured illuminated symbol	
<b>Display</b>		
Display:	colored TFT, 26 x 26 mm	
Resolution:	240 x 240 pixels	
<b>Outputs</b>		
Acoustic output:	piezo-changer	
<b>Communication</b>		
Installation BUS:	BUS	
<b>Power supply</b>		
Supply voltage/tolerance:	27 V DC, -20/+10 %	
Dissipated power:	max. 0.5 W	
Rated current:	85 mA (at 27 V DC), from BUS	
<b>Connection</b>		
Terminals:	0.5 - 1 mm <sup>2</sup>	
<b>Operating conditions</b>		
Relative humidity:	max. 80 %	
Operating temperature:	-20 to +55 °C	
Storing temperature:	-30 to +70 °C	
Protection degree:	IP20	
Overvoltage category:	II.	
Pollution degree:	2	
Operation position:	any	
Installation:	on the wall, observing the conditions for correct installation of the thermostat	
<b>Dimensions and weight</b>		
Dimensions:	94 x 94 x 41 mm   100 x 100 x 8 mm	
Weight:	156 g	
Standards:	EN 63044-1	

- Glass room thermo-regulator GRT3-70 is part of a comprehensive range of glass iNELS control units for apartments, guest room management system (GRMS) and serves to regulate the temperature in the room.
- Comes with bigger display and new design compared to the previous version GRT3-50.
- GRT3-70 thermo-regulator has a display for displaying the current room temperature and desired temperature. To adjust the required temperature, it is possible to use the touch buttons with symbols "-" and "+".
- GRT3-70 is also suitable for controlling fan coils and fan speed can be easily adjusted by using the touch buttons with symbols.
- Thermo-regulator GRT3-70 also features its touch buttons whose function can be adjusted by software, for example fan coil on/off, heating/cooling or comfort temperature for heating or cooling.
- Thermo-regulator is equipped with an integrated temperature sensor for ambient temperature measurement.
- The glass room thermo-regulator is a design component of the iNELS system and is available in elegant black (GRT3-70/B) and white (GRT3-70/W) version.
- Engraving of symbols is possible upon a request.
- Individual symbols can be illuminated.
- GRT3-70 are designed for mounting into an installation box.

Other variants

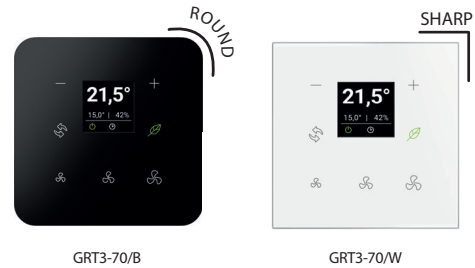

Connection

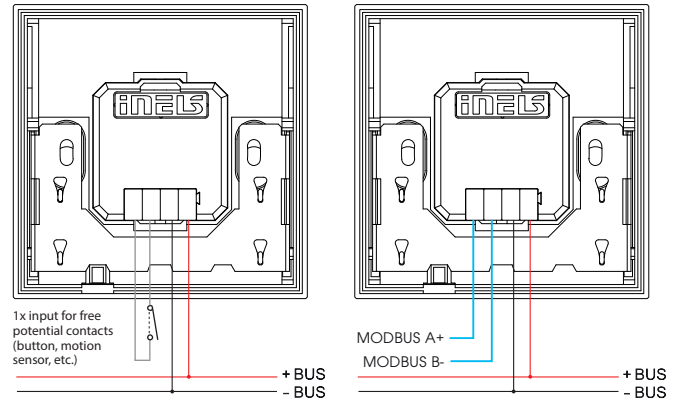

Another view



GRT3-70/W

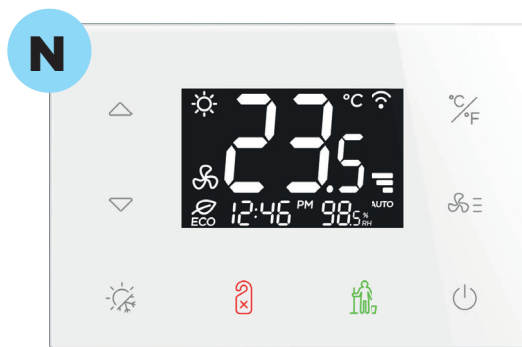



EAN code                      Order Code:                      The picture of device is illustrative, the icons  
 GRT3-100/W: 8595188191746    GRT3-100/W: 9174                      (symbols) are configurable by the customer.  
 GRT3-100/B: 8595188191739    GRT3-100/B: 9173

Technical parameters	GRT3-100/B	GRT3-100/W
<b>Power supply</b>		
Power supply voltage:	110 - 230V AC, 50-60Hz, L and N terminals	
Apparent/loss power input:	5 VA/3 W	
Supply voltage tolerance:	± 10%	
<b>Outputs</b>		
Relays:	5x switching / 5A / 250V AC1 / 1385VA	
Contact life:	mechanical: 10 mil. / electrical 100.000 switches	
Analog Output:	2x 0-10V, 10 mA	
<b>Inputs (external)</b>		
Binary:	1x potential-free contact, terminals IN1/IN2 against GND, maximum wire length 30m	
Temperature:	1x for external temperature sensor TC/TZ, terminals IN1/T & IN2/TC, temperature range -20 to +120 °C, accuracy ± 0.5 °C	
<b>Sensors (internal)</b>		
Temperature:	range 0 to +55 °C, accuracy ± 0.5 °C from the range	
Humidity:	0 - 99% RH, accuracy ± 3 °C from the range	
Proximity:	backlight activation when zooming <25 cm	
Lighting:	adaptive backlight control of the display and buttons	
<b>Communications</b>		
iNELS BUS:	BUS	
<b>Control and display</b>		
Display:	LCD (VA/TN), active area 54x34mm	
Buttons:	8x, capacitive, backlit	
<b>Connection</b>		
Terminals (BUS):	0.2 - 1.5 mm <sup>2</sup>	
Terminals (relay):	min. 0.2 mm <sup>2</sup> /max 1.5 mm <sup>2</sup> with sleeve	
Terminals block:	16 pole, screwless (push-in)	
<b>Mechanics</b>		
Operating temperature:	- 0 to 50 °C / max 90% RH	
Storage temperature:	- 20 to 60 °C	
Enclosure:	IP30 (mounted)	
Overvoltage category:	II.	
Pollution degree:	2	
Working position:	horizontal	
Installation:	on EU or British box with 60 mm bolt spacing	
Dimension:	120x80x27 mm	
Weight:	230g	
Shape/edges:	sharp	
Color (glass and plastic)	White	Black
Standard:	EN 63044-1	

- Glass room thermo-regulator GRT3-100 is part of a comprehensive range of glass iNELS control units for apartments, guest room management system (GRMS) and serves to regulate the temperature in the room.
- The glass room thermo-regulator is a design component of the iNELS system and is available in elegant black (GRT3-100/B) and white (GRT3-100/W) version.
- GRT3-100 thermo-regulator has a display for displaying the current room temperature and desired temperature. To adjust the required temperature, it is possible to use the touch buttons with symbols "-" and "+".
- The GRT3-100 is equipped with 5x 8 A relay output for fan speed and valves. It is also equipped with analog-to-digital input (AIN/DIN), which can be used to connect potential-free contact or external temperature sensor TC/ TZ (for example temperature measurement of the room or floor).
- GRT3-100 is also suitable for controlling fan coils and fan speed can be easily adjusted by using the touch buttons with symbols.
- Thermo-regulator GRT3-100 also features its touch buttons whose function can be adjusted by software, for example fan coil on/off, heating/cooling or comfort temperature for heating or cooling.
- Thermo-regulator is equipped with an integrated temperature sensor for ambient temperature measurement.
- Engraving of symbols is possible upon a request.
- Individual symbols can be illuminated.
- GRT3-100 are designed for mounting into wall.

#### Options: external temperature sensors

TC-0	TC-3	TC-6, TC-12	NTC 12K
			2 x 0,25 mm <sup>2</sup>
100 mm	3 m		PVC, IP67
Order code: 209970800010	Order code: 209970800011		

Create your glass design here:  
[icons.inels.com](https://icons.inels.com)



Buttons and display description

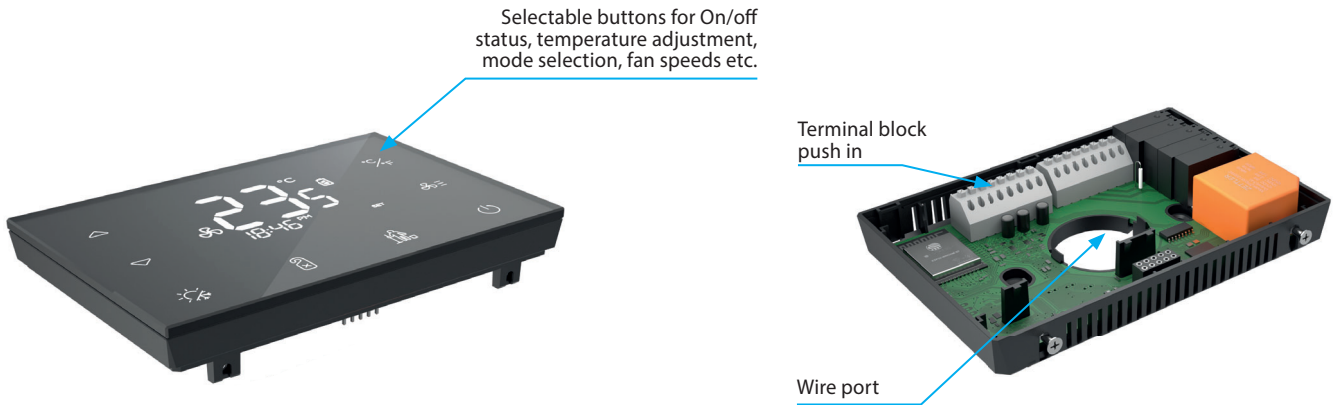

Connection

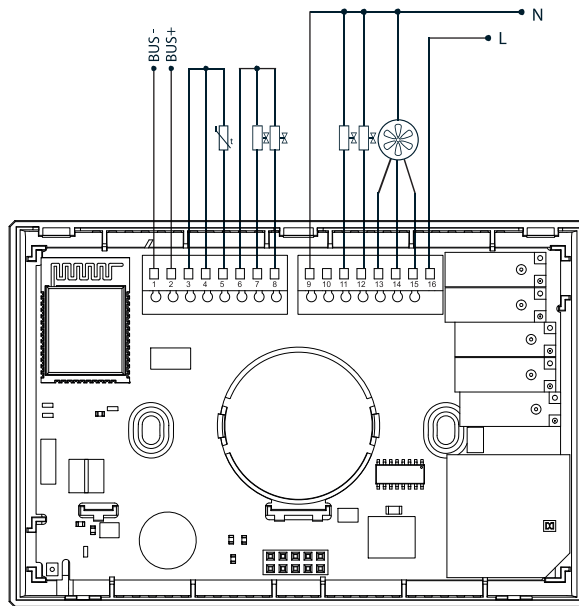

Another view



GRT3-100/W



GRT3-100/B

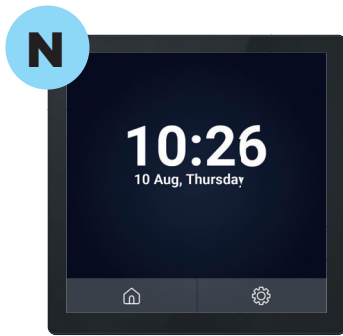

## Technical parameters

## EST4

### Hardware / Software

Hardware	ARM A7 Single-Core 1.2 GHz / 128MB DDR3 Ram / 256 MB Nand flash
Software:	OS Linux 3.4

### Display

Type:	IPS 4" 480 x 480 resolution
Display:	400 cd/m2 luminance
Touch part:	5 Point capacitive touchscreen

### Power Supply

Supply voltage/tolerance:	24VDC -or- 48 VDC In
PoE	POE IEEE 802.3af
Dissipated power:	Power consumption max. 10W

### Connection

Standard Interfaces:	(1x) LAN RJ45 10/100Mbps interface (1x) Add-On (optional interface) Port (1x) Digital Out (open collector 5V 100mA) (1x) Digital In
----------------------	--

### Optional Interfaces

	iNELS BUS
	RS485 (EIA-485) (RS4)
	Galvanic isolated RS485 Modbus (A-GMD)
	VRF mainline communication (A-VRM -or- A-VRR)
	Zigbee 3.0 (BCU-S24-ZGB -or- BCU-POE-ZGB)

### Built-in Sensors

Humidity sensor:	range 0% up to 100% RH
Temperature sensor:	range -40°C up to +125°C

### Operating conditions

Working temperature:	-10°C – +60°C
Humidity:	5% – 90% at 25°C

### Dimensions and weight

Dimensions:	92 x 92 x 29 mm
Standard:	EN 63044-1, EN 62368-1

## Accessories

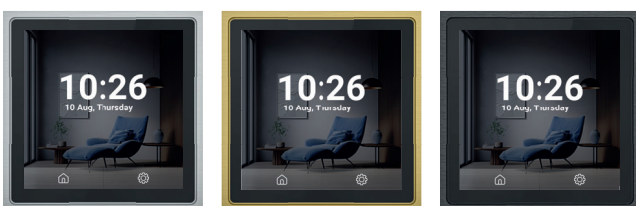

● Silver frame

● Gold frame

● Black frame

FEST4S/B	EST4 Aluminium Frame sharp - Black
FEST4S/S	EST4 Aluminium Frame sharp - Silver
FEST4S/G	EST4 Aluminium Frame sharp - Gold
FEST4C/B	EST4 Aluminium Frame curve - Black
FEST4C/S	EST4 Aluminium Frame curve - Silver
FEST4C/G	EST4 Aluminium Frame curve - Gold
PSU24-iR	Power Supply 24VDC Railmount

- The EST4 offers a feature-rich and versatile solution for control and monitoring applications, with its powerful hardware, user-friendly display, and support for various interfaces and sensors. Its temperature and humidity tolerance make it a reliable choice in different operating environments.
- Featuring a high-quality 4" IPS display with a resolution of 480 x 480 and a luminance of 400 cd/m2, the EST4 offers crisp and clear visuals for an excellent user experience.
- The device runs on Linux 3.4 operating system supporting up to 200 UI objects and 1000 BMS points.
- Equipped with an ARM A7 Single-Core 1.2 GHz processor, 128MB DDR3 RAM, and 256MB Nand flash, ensuring reliable performance for various applications.
- Integrated with essential sensors, the device includes a humidity sensor with a range of 0% up to 100% RH and a temperature sensor covering a range from -40°C up to +125°C, enabling efficient environmental monitoring.
- The EST4 comes with a standard LAN RJ45 10/100Mbps interface, ensuring easy network connectivity for data transfer and communication.
- The EST4 offers a variety of optional interfaces for enhanced connectivity and compatibility. These include iNELS, RS485, Modbus, VRF, and Zigbee 3.0
- The EST4 operates within a working temperature range of -10°C to +60°C.
- The device can be powered by either 24VDC or 48VDC input, and it also supports Power over Ethernet (POE IEEE 802.3af), providing flexibility in power options.
- Configuration, programming and update applications over the Skythings platform.

## Connection

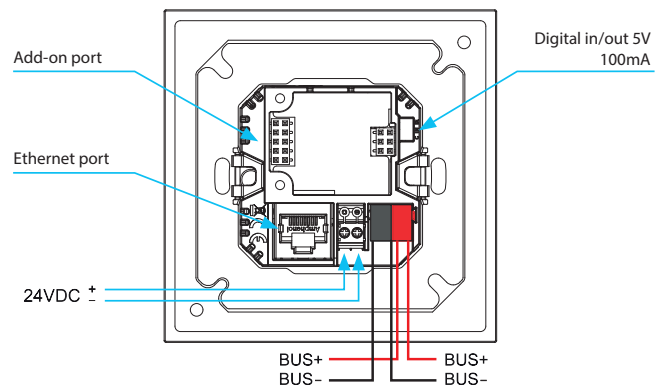

## Another view





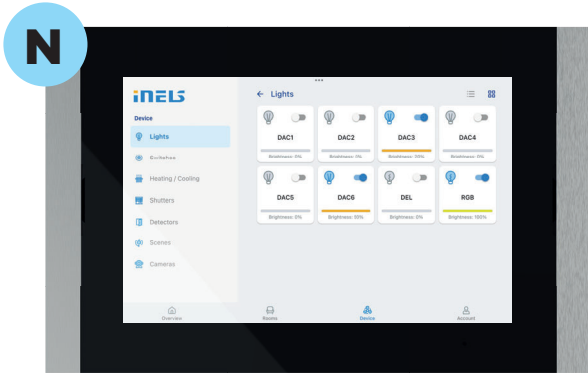

EST8/B 8" Panel w/ Black Bars  
 EST8/S 8" Panel w/ Silver Bars  
 EST8/G 8" Panel w/ Gold Bars

EST8/B-POE 8" Panel w/ Black Bars-POE  
 EST8/S-POE 8" Panel w/ Silver Bars-POE  
 EST8/G-POE 8" Panel w/ Gold Bars-POE



Technical parameters		EST8
<b>Hardware / Software</b>		
Hardware	Quad-Core 1.2 GHz / 1GB DDR3 Ram / 8GB Nand flash	
Software:	OS Android 7.1 with iNELS application	
<b>Display</b>		
Type:	IPS 10" 1280 x 800 re Via solution	
Display:	300 cd/m2 luminance	
Touch part:	5 point capacitive touchscreen	
<b>Power Supply:</b>		
Supply voltage/tolerance:	24 VDC	
PoE	PoE IEEE 802.3af (optional w/PSU-TP-POE)	
Dissipated power:	Power consumption max. 13W	
<b>Connection</b>		
Ethernet:	1x LAN RJ45	
Communication speed:	10/100 Mbps interface	
<b>Optional Interfaces</b>		
	iNELS BUS	
	RS485 (EIA-485) (RS4)	
	Galvanic isolated RS485 Modbus (A-GMD)	
	VRF mainline communication (A-VRM -or- A-VRR)	
	Zigbee 3.0 (BCU-S24-ZGB -or- BCU-POE-ZGB)	
<b>Built-in Sensors</b>		
Humidity sensor:	range 0% up to 100% RH	
Temperature sensor:	range -40°C up-to +125°	
<b>Operating conditions</b>		
Working temperature:	-10°C – +60°C	
Humidity:	5% – 90% at 25°C	
<b>Dimensions and weight</b>		
Dimensions:	243 x 149 x 42 mm	
Standard:	EN 63044-1	

**Accessories**

BOX-F-EST8 Flush Mount Box for 8" Touch Panel  
 BOX-W-EST8 On-Wall Mount Box for 8" Touch Panel  
 PSU24-iR Power Supply 24VDC Railmount

- The EST8 offers a feature-rich and versatile solution for control and monitoring applications, with its powerful hardware, user-friendly display, and support for various interfaces and sensors. Its temperature and humidity tolerance make it a reliable choice in different operating environments.
- Featuring IPS 8" 1280 x 800 resolution 350 cd/m2 luminance with 5 point capacitive touchscreen.
- The device runs on OS Android 6.0 operating system with A64 Quad-Core 1.3 GHz/1GB DDR3 Ram / 8GB Nand flash supporting up to 1000 BMS points.
- EST8 touch panel designed to control iNELS with Android OS via iNELS applications.
- Integrated speakers and microphone are primarily designed for intercom operation
- Integrated with essential sensors, the device includes an Ambient illuminance measurement sensor , humidity sensor and a temperature sensor, enabling efficient environmental monitoring.
- The EST8 comes with a standard LAN RJ45 10/100Mbps interface, ensuring easy network connectivity for data transfer and communication.
- The EST8 offers a variety of optional interfaces for enhanced connectivity and compatibility. These include iNELS, RS485, Modbus, VRF, and Zigbee 3.0
- The EST8 operates within a working temperature range of -10°C to +60°C.
- The device can be powered by either 24VDC, and it also supports Power over Ethernet (POE IEEE 802.3af), providing flexibility in power options max 30W.
- Configuration, programming, and update applications over the Skythings platform.

**Device description**

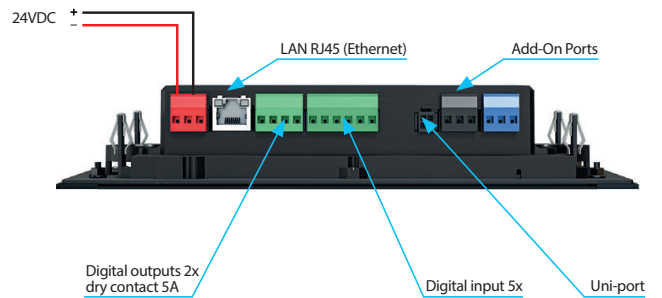

N

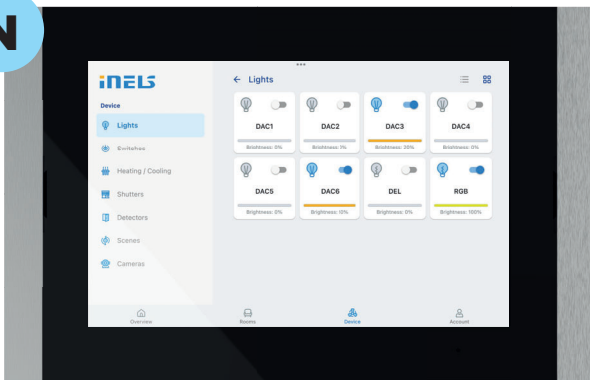

EST10/B 10" Panel w/ Black Bars  
EST10/S 10" Panel w/ Silver Bars  
EST10/G 10" Panel w/ Gold Bars

EST10/B-POE 10" Panel w/ Black Bars-POE  
EST10/S-POE 10" Panel w/ Silver Bars-POE  
EST10/G-POE 10" Panel w/ Gold Bars-POE

## Technical parameters

### EST10

#### Hardware / Software

Hardware	Quad-Core 1.2 GHz / 1GB DDR3 Ram / 8GB Nand flash
Software:	OS Android 7.1 with iNELS application

#### Display

Type:	IPS 10" 1280 x 800 re Via solution
Display:	300 cd/m2 luminance
Touch part:	5 point capacitive touchscreen

#### Power Supply:

Supply voltage/tolerance:	24 VDC
PoE	PoE IEEE 802.3at (optional w/PSU-TP-POE)
Dissipated power:	Power consumption max. 13W

#### Connection

Ethernet:	1x LAN RJ45
Communication speed:	10/100 Mbps interface

#### Optional Interfaces

	iNELS BUS
	RS485 (EIA-485) (RS4)
	Galvanic isolated RS485 Modbus (A-GMD)
	VRF mainline communication (A-VRM -or- A-VRR)
	Zigbee 3.0 (BCU-S24-ZGB -or- BCU-POE-ZGB)

#### Built-in Sensors

Humidity sensor:	range 0% up to 100% RH
Temperature sensor:	range -40°C up-to +125°

#### Operating conditions

Working temperature:	-10°C – +60°C
Humidity:	5% – 90% at 25°C

#### Dimensions and weight

Dimensions:	307 x 194.6 x 39.5 mm
Standard:	EN 63044-1

#### Accessories

**BOX-F-EST10** Flush Mount Box for 10" Touch Panel  
**PSU24-IR** Power Supply 24VDC Railmount

- The EST10 offers a feature-rich and versatile solution for control and monitoring applications, with its powerful hardware, user-friendly display, and support for various interfaces and sensors. Its temperature and humidity tolerance make it a reliable choice in different operating environments.
- Featuring IPS 10" 1280 x 800 resolution 350 cd/m2 luminance with 5 point capacitive touchscreen.
- The device runs on OS Android 6.0 operating system with A64 Quad-Core 1.3 GHz/1GB DDR3 Ram / 8GB Nand flash supporting up to 2000 BMS points.
- EST10 touch panel designed to control iNELS with Android OS via iNELS applications.
- Integrated speakers and microphone are primarily designed for inter-com operation
- Integrated with essential sensors, the device includes an Ambient illumination measurement sensor, humidity sensor and a temperature sensor, enabling efficient environmental monitoring.
- The EST10 comes with a standard LAN RJ45 10/100Mbps interface, ensuring easy network connectivity for data transfer and communication.
- The EST10 offers a variety of optional interfaces for enhanced connectivity and compatibility. These include iNELS, RS485, Modbus, VRF, and Zigbee 3.0
- The EST10 operates within a working temperature range of -10°C to +60°C.
- The device can be powered by either 24VDC, and it also supports Power over Ethernet (POE IEEE 802.3af), providing flexibility in power options max 30W.
- Configuration, programming, and update applications over the Skythings platform.

#### Device description

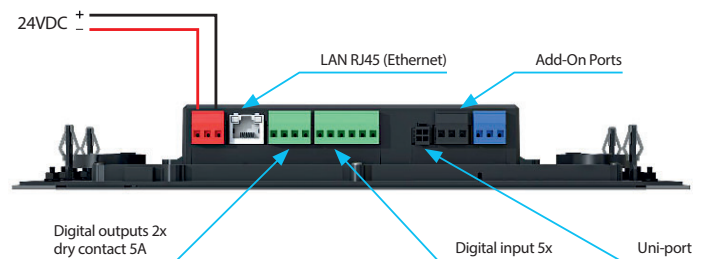

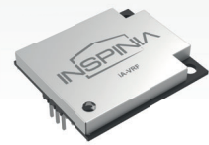

**Technical parameters**

**ADD-ONS**



Order Code:	iA-GRS4
Supported Media:	RS485
Power Consumption on Bus:	None
Isolation Type:	Board-to-board Galvanic Isolated
Dimensions:	35x30 mm



Order Code:	iA-ZGB
Supported Media:	Zigbee
Power Consumption on Bus:	None
Isolation Type:	None
Dimensions:	35x30 mm



Order Code:	iA-INL
Supported Media:	iNELS BUS
Power Consumption on Bus:	None
Isolation Type:	None
Dimensions:	35x30 mm

**Technical parameters**

**ADD-ONS**



Supported Brand	Order Code	Terminal Name	Communication Line
Samsung	iA-VSM	F1-F2 / R1-R2	NASA
Daikin	iA-VDK	F1-F2	D3 Net
Hitachi	iA-VHT	1-2	TCC Link
LG	iA-VLG	A-B	Inter A-B
Mitsubishi Electric	iA-VME	M1-M2	M-Net TB3/7
Mitsubishi Heavy	iA-VMH	A-B	S Slink I/II
Midea/Chigo	iA-VMD	X-Y-E	X Y E
Panasonic/Sanyo	iA-VPA	U1-U2	S3 Net
Toshiba	iA-VTO	U1-U2	TCC Link

**License**

iL-P100:	100 BMS Points License
iL-P500:	500 BMS Points License
iL-P1000:	1000 BMS Points License
iL-VRF-U1:	1 Unit VRF License
iL-VRF-C1:	1 Channel - 64 Unit VRF License
iL-VRF-C2:	2 Channel - 128 Unit VRF License

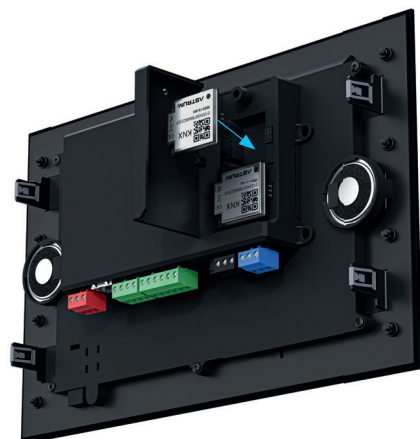



EAN code  
iNELS Bridge 24V DC: 8595188185097  
Order Code: 8524

### Technical parameters

### iNELS Bridge

#### Communication

Communication network:	Ethernet
Pre Installed software:	Connection Server, Home Assistant, Asterisk, MQTT Broker

#### Ethernet

Connectors:	RJ-45
Communication speed:	10/100Mb
Ethernet status indication:	LED link
Preset IP address (ETH):	DHCP, mDNS

#### Power supply

Version 24V DC:	8-36 V DC/1 A
-----------------	---------------

#### Operating conditions

Operating temperature:	-20 to +55 °C
Storage temperature:	-25 to +70 °C
Humidity:	max. 80%
Degree of protection:	IP20
Overvoltage category:	II.
Degree of pollution:	2
Operating position:	any
Installation:	DIN rail EN 60715
Design:	1-MODULE
Terminal:	max. 2.5 mm <sup>2</sup>

#### Dimensions and weight

Dimensions:	94 x 17.6 x 64mm
Weight:	72 g
Standard:	EN 63044-1, EN 62368-1

- iNELS Bridge works as a gateway for connecting third party devices and integrating them into the iNELS environment.
- It is a one module hardware contain powerful linux based computer.
- The unit comes with an option of pre-installed Connection server, Home assistant with iNELS driver and Asterisk.
- The server uses the open Home Assistant platform, which contains more than 1000 existing integrations.
- The connection server is providing a communication environment between iNELS BUS System with the third-party devices, for which their protocols are also translated and submitted.
- iNELS Bridge is equipped ethernet port for fast and easy communication.
- The configuration is happening on its own web interface, where the default IP address is not fixed. (The IP address is assigned from the DHCP server and it's needed to be known when we're connected to the network).
- The device can be powered by 24VDC input, and it also supports Power over Ethernet (Passive POE), providing flexibility in power options.

### Device description

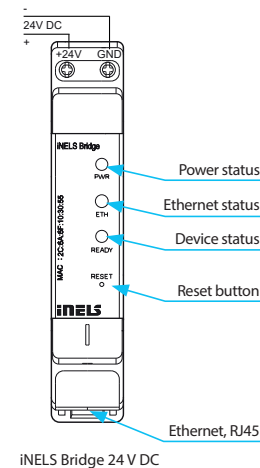

iNELS Bridge 24 V DC

### Integrations and protocols

#### Integrations



#### Protocols



#### iNELS Bridge





EAN code  
 Connection server II: 8595188185080  
 Order Code: 8508

Technical parameters	Connection Server II
Power:	USB Type-C PD 2.0 with 9V/2A, 12V/2A, 15V/2A , 20V/2A
Video Output:	HDMI
Audio Output:	3.5mm jack with mic
Processor (CPU):	64bits hexa core processor, Dual Cortex-72, frequency 1.8GHz with qual Cortex-A53, frequency 1.4GHz
Memory (SDRAM):	4 GB
Communication Interface:	Gigabit Ethernet, dual-band 802.11ac WiFi 5, Bluetooth 5.0
Connecting peripherals:	2x USB 3.0 , 2x USB 2.0
Dimensions:	92,9 x 65 x 50,6 mm (l,w,h)
Standard:	EN 63044-1, EN 62368-1

- The connection server is providing a communication environment between iNELS BUS System with the third party devices, for which their protocols are also translated and submitted.
- The iNELS application's environment enables us to control all these technologies from just one app.
- If the connection server is present in the installation, then it enables option for controlling the installation by application - lighting, blinds, heating, etc., also IP cameras, intercom, air conditioning.
- It also allows the communication with the domestic voice intercom 2N. It can also arrange the information from the weather station Giom or data from energy meters (electricity, water, gas), which is visualized in clear graphs.
- The device connection server uses the Rock Pi hardware and the apps requires a license relative to the MAC address of the device.
- While connecting with the devices connection server, it's recommended to use an uninterruptible power supply (UPS), which ensures that, there will be no power outage.
- The configuratun is happening on its own web interface, where the default IP address is not fixed. (The IP address is assigned from the DHCP server and it's needed to be known when we're connected to the network).

Infrastructure example

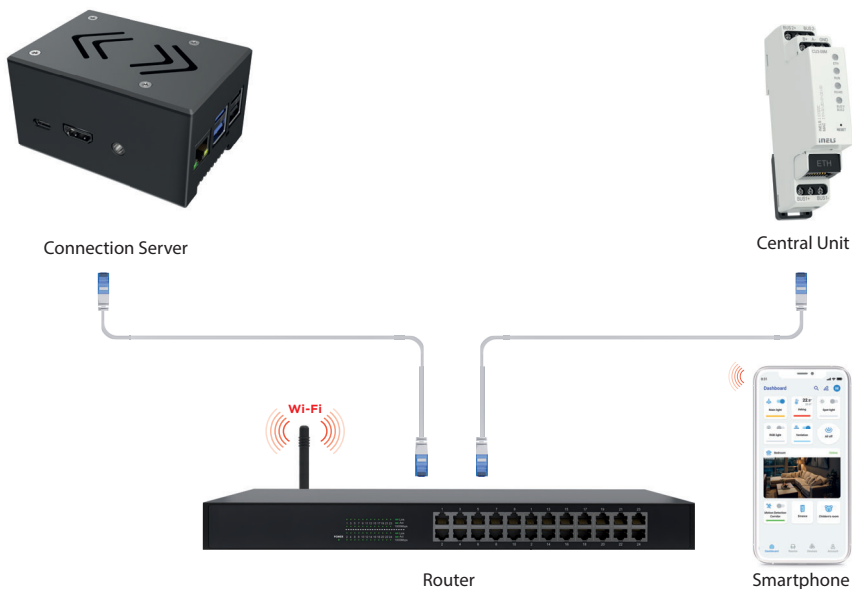

# What is MQTT?

## (Message Queuing Telemetry Transport)



MQTT (Message Queuing Telemetry Transport) is a communication protocol designed for efficient and reliable data transmission between devices or applications over a network. It was developed for use in situations where messages need to be sent with minimal overhead and low latency, which is crucial in limited or unstable network conditions, such as the Internet of Things (IoT) or mobile networks.

### The main features of MQTT

**1. Publish-Subscribe Model:** MQTT utilizes the "publish-subscribe" model, where clients can publish messages on specific topics, and other clients subscribed to these topics can receive the messages. This model provides a decentralized way of communication and allows a larger number of devices (subscribers) to respond to events from various publishers.

**2. Low Data Overhead:** The MQTT protocol is designed with efficiency and low data overhead in mind. The message header is very small, reducing bandwidth demands and enabling efficient data transmission even on resource-constrained devices, such as sensors or microcontrollers.

**3. QoS (Quality of Service):** MQTT allows you to set the level of quality of service for message delivery according to the application's needs. There are three QoS levels:

- **QoS 0:** It provides "at most once" message delivery, meaning messages may be lost, but they are transmitted with minimal overhead.
- **QoS 1:** It ensures "at least once" message delivery, but there may be instances of duplicate delivery.
- **QoS 2:** It guarantees "exactly once" message delivery, which is the most reliable level but requires the most overhead.

**4. Retained Messages:** MQTT allows the broker to retain the last message on a specific topic. When a new client subscribes to that topic, it immediately receives this retained message. This is useful, for example, in situations where we want to obtain the current state of a device after it connects.

**5. Easy Connection:** MQTT is designed to make it easy to connect to a broker and start publishing or subscribing to messages. MQTT client implementations are available for various platforms and programming languages, making it easy to integrate them into different applications.

**6. Broad Support:** MQTT is supported by a wide range of devices and platforms, making it an ideal choice for communication in IoT environments and other applications that require reliable and low-overhead communication.

Thanks to these features, MQTT has become a popular protocol for communication in IoT, sensor networks, telemetry, tracking systems, and other applications where efficient and reliable data transmission over the network is crucial.

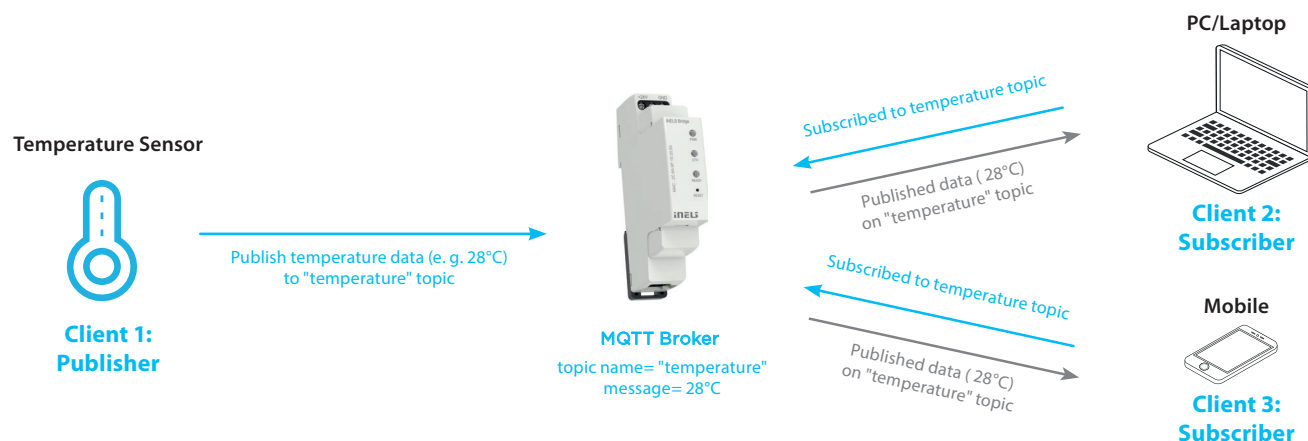

### iNELS supports MQTT

The iNELS gateways, both in wired (CU3-07/08M) and wireless (eLAN-RF-103) versions, have implemented bidirectional MQTT communication. In practice, this means that real-time data from all iNELS system components are sent to the MQTT Broker (iNELS Bridge). Additionally, thanks to the bidirectional communication, these components can be freely controlled.

This approach makes the iNELS system open for easy integration into superior BMS (Building Management Systems) and PMS (Property Management Systems). It can be easily connected to third-party systems and implemented into various applications.

#### iNELS Bridge

The revolutionary iNELS Bridge device is unique in that it combines several technologies. Its core feature is the pre-installed MQTT Broker, a software platform that will receive, store, and mediate all MQTT communication within one or even multiple installations.

#### Home Assistant

Home Assistant is a popular environment for creating and managing all automation systems. In this environment, users or administrators can create their own scenarios or automations across different technologies within the property. An integral part of this is a user-friendly application for mobile platforms or computers.

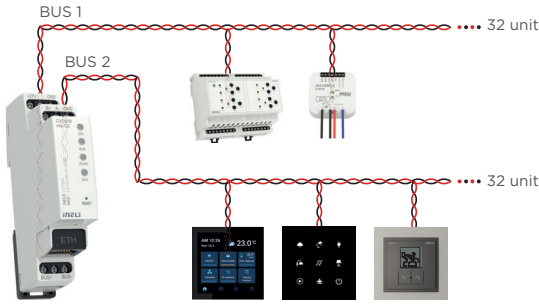

Central unit



INELS Bridge



eLAN Gateway



MQTT Broker

Home Assistant



Cars + chargers

Appliances



**Miele**  
**SIEMENS**  
**SONOS**  
**iRobot**

... and many others.

**WhatsApp**  
**amazon alexa**  
**Google Home**  
**Works with Apple HomeKit**



Apps and voice control

Protocols

**BACnet** **KNX**  
**Modbus** **M-Bus**  
**ZWAVE**

**protel** **FLOWBOX** **NETX AUTOMATION**  
**Node-RED** **PROMOTIC**  
**Opera** **SKY THINGS**

Platforms

BMS



**EasyIO**  
**niagara framework**  
**iRidi**

**Fronius**  
**NIBE**



HVAC + photovoltaics



Radio



Music

Video-  
telephone

Intercom



Audiozone

**Technical parameters****LARA Radio****Internet Radio**

Supported data transfer formats:

mp3, ogg, acc

**Control/Settings**

Front panel:

touchscreen buttons

Communication Ethernet:

via PC setting up and communicating  
SW LARA Configurator

Button RESET:

restart product/  
reset product to factory settings**Interface ethernet**

Communications interface:

10/100 Mbps

Connector:

RJ45

Max. cable length UTP  
with power:

50 m

**Display**

Type:

color OLED

Resolution:

128 x 128 pixels

Visible surface:

26 x 26 mm

**Power supply**

Supply:

Passive PoE 24 V DC/1.25 A

Min. input:

1.4 W

Max. input:

26 W (peak at maximum playback performance)

**Amplifier**

Amplifier:

stereophonic class D with digital output control

Max. amplifier output:

2 x 10 W/8 Ω

**Inputs/Outputs**

Microphone:

NO

Audio input:

3.5 stereo jack

Audio output 1:

terminals LINE OUT  
(used for external amplifier)\*

Audio output 2:

terminals OUT L/OUT R  
(speaker output from int. amplifier)**Connection**

Terminal block:

0.5 - 1 mm<sup>2</sup>**Other data**

Working temperature:

0 to + 55 °C

Protection degree:

IP20

Overvoltage category:

II.

Pollution degree:

2

Installation:

in an installation box

**Dimensions and weight**

Dimensions:

- plastic:

85 x 85 x 46 mm

- metal, glass, wood, granite:

94 x 94 x 46 mm

Weight:

209 g (plastic frame)

Standard:

EN 63044-1, EN 62368-1

- A music and internet radio player - all in the dimension of a switch and a luxurious LOGUS<sup>90</sup> design.
- LARA Radio - when connected to the Internet, it can play streaming radio stations and you can store up to 40 of them. But you can also select from thousands of radio stations from across the globe, which provide data for correct connection.
- LARA Radio can play content from an external music source, which can be a smart phone or e.g. an MP3 player. These devices are connected to a 3.5mm stereo jack audio input, located underneath the front panel.
- Touch control is performed on the device front panel (six capacity buttons available), or LARA Dio.
- The basic device settings (network connection, language, audio input) are performed via the display and a simple menu controlled from capacity buttons on the device front cover. Further settings (selection of stations, connection with the server, updating firmware, etc.) are configured via computer and the software LARA Configurator.
- LARA Radio is equipped with an OLED colored display with the size of 1.5". The display also shows basic information about playing music, which also serves the orientation in the menu settings, etc.
- LARA Radio has an integrated amplifier with 2x 10 W output, thus greatly facilitating device installation in places where such output suffices. LARA is used e.g. to provide premium sound to the kitchen, bathrooms, waiting rooms, offices, reception desks, entrance halls, operating rooms or wellness facilities.
- LARA is powered by PoE with maximum voltage level 27 V DC/ 1000 mA. So connecting and communicating with just one cable (UTP) is a major advantage.
- For LARA, an entire series of accessories is ready for connection (PoE adapters, PoE switches), speakers (in a frame, walls or ceilings) and installation (cables, box, etc.).
- Complies with standards IEEE 802.3u (100BASE-Tx).
- Automatic cable crossing detection of Ethernet cable - MDIX.

**EAN code**

LARA Radio white:	8595188148719
LARA Radio ivory:	8595188149242
LARA Radio ice:	8595188149228
LARA Radio pearl:	8595188149259
LARA Radio aluminium:	8595188149211
LARA Radio grey:	8595188149235

\* The cable from the LINE OUT terminals must be shielded, max. length should not exceed 5 m.



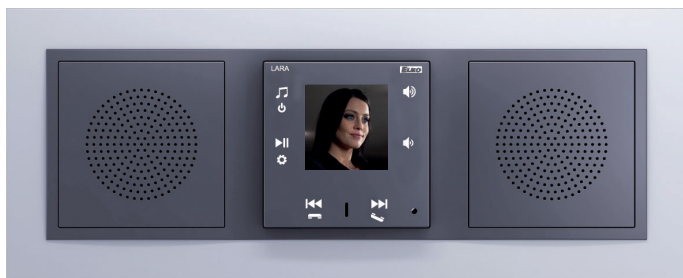
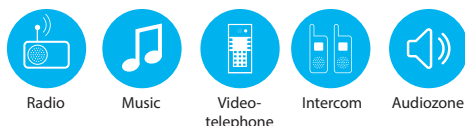

Technical parameters		LARA Intercom
<b>Internet Radio</b>		
Supported data transfer formats:	mp3, ogg, acc	
<b>Control/Settings</b>		
Front panel:	touchscreen buttons	
Communication Ethernet:	via PC setting up and communicating SW LARA Configurator	
Button RESET:	restart product/ reset product to factory settings	
<b>Interface ethernet</b>		
Communications interface:	10/100 Mbps	
Connector:	RJ45	
Max. cable length UTP with power:	50 m	
<b>Display</b>		
Type:	color OLED	
Resolution:	128 x 128 pixels	
Visible surface:	26 x 26 mm	
<b>Power supply</b>		
Supply:	Passive PoE 24 V DC/1.25 A	
Min. input:	1.4 W	
Max. input:	26 W (peak at maximum playback performance)	
<b>Amplifier</b>		
Amplifier:	stereophonic class D with digital output control	
Max. amplifier output:	2 x10 W/8 Ω	
<b>Inputs/Outputs</b>		
Microphone:	YES	
Audio input:	3.5 stereo jack	
Audio output 1:	terminals LINE OUT (used for external amplifier)*	
Audio output 2:	terminals OUT L/OUT R (speaker output from int. amplifier)	
<b>Connection</b>		
Terminal block:	0.5 - 1 mm <sup>2</sup>	
<b>Other data</b>		
Working temperature:	0 to + 55 °C	
Protection degree:	IP20	
Overvoltage category:	II.	
Pollution degree:	2	
Installation:	in an installation box	
<b>Dimensions and weight</b>		
Dimensions:		
- plastic:	85 x 85 x 46 mm	
- metal, glass, wood, granite:	94 x 94 x 46 mm	
Weight:	209 g (plastic frame)	

\* The cable from the LINE OUT terminals must be shielded, max. length should not exceed 5 m.

- LARA Intercom offers users 5 different functions and expands even more options to Lara Radio - music players and internet radio stations within the range of LOGUS<sup>90</sup> switch designs.
- LARA Intercom provides an extra functionality and videophone intercom.
- Thanks to videophone function, now it is possible to have a voice communication between LARA and the sound of the door (IP Intercom), so with someone visiting and standing in front of the house, we can see that on LARA display as part of this function which increases the security feeling and safety besides of course, the comfort for the user.
- LARA Intercom is equipped with an OLED colored display with the size of 1.5", which is used to transfer images and sounds from the door camera properly. The display also shows basic information about playing music, which also serves the orientation in the menu settings, etc.
- The intercom function can also be used for communications between all the family members throughout the whole house, thanks to two way voice communications possibilities between different LARA units.
- LARA Intercom continues to offer three functions that are also supported by LARA Radio - when connected to the Internet, it can play streaming radio stations and you can store up to 40 of them. But you can also select from thousands of radio stations from across the globe, which provide data for correct connection.
- LARA Intercom can play content from an external music source, which can be a smart phone or e.g. an MP3 player. These devices are connected to a 3.5mm stereo jack audio input, located underneath the front panel. You can also use LARA for streaming your favorite music from Spotify Premium.
- Touch control is performed on the device front panel (six capacity buttons available), or LARA Dio.
- The basic device settings (network connection, language, audio input) are performed via the display and a simple menu controlled from capacity buttons on the device front cover. Further settings (selection of stations, connection with the server, updating firmware, etc.) are configured via computer and the software LARA Configurator.
- LARA Intercom has an integrated amplifier with 2x 10 W output, thus greatly facilitating device installation in places where such output suffices. LARA is used e.g. to provide premium sound to the kitchen, bathrooms, waiting rooms, offices, reception desks, entrance halls, operating rooms or wellness facilities.
- LARA is powered by PoE with maximum voltage level 27 V DC/ 1000 mA. So connecting and communicating with just one cable (UTP) is a major advantage.
- For LARA, an entire series of accessories is ready for connection (PoE adapters, PoE switches), speakers (in a frame, walls or ceilings) and installation (cables, box, etc.).
- Complies with standards IEEE 802.3u (100BASE-Tx).
- Automatic cable crossing detection of Ethernet cable - MDIX.

EAN code	
LARA Intercom white:	8595188149389
LARA Intercom ivory:	8595188149419
LARA Intercom ice:	8595188149396
LARA Intercom pearl:	8595188149426
LARA Intercom aluminium:	8595188149372
LARA Intercom grey:	8595188149402

Touchscreen operation



Applications control

Operations, using the application for, LARA Dio and iNELS Home Control for Android and iOS smartphones and tablets.

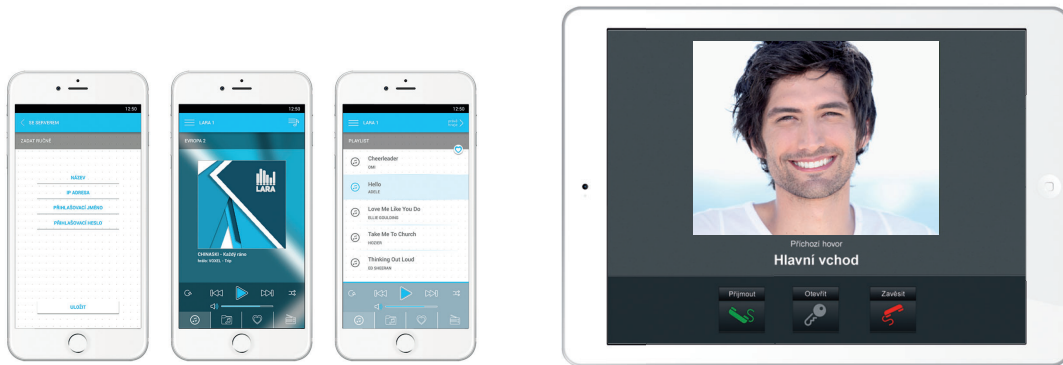

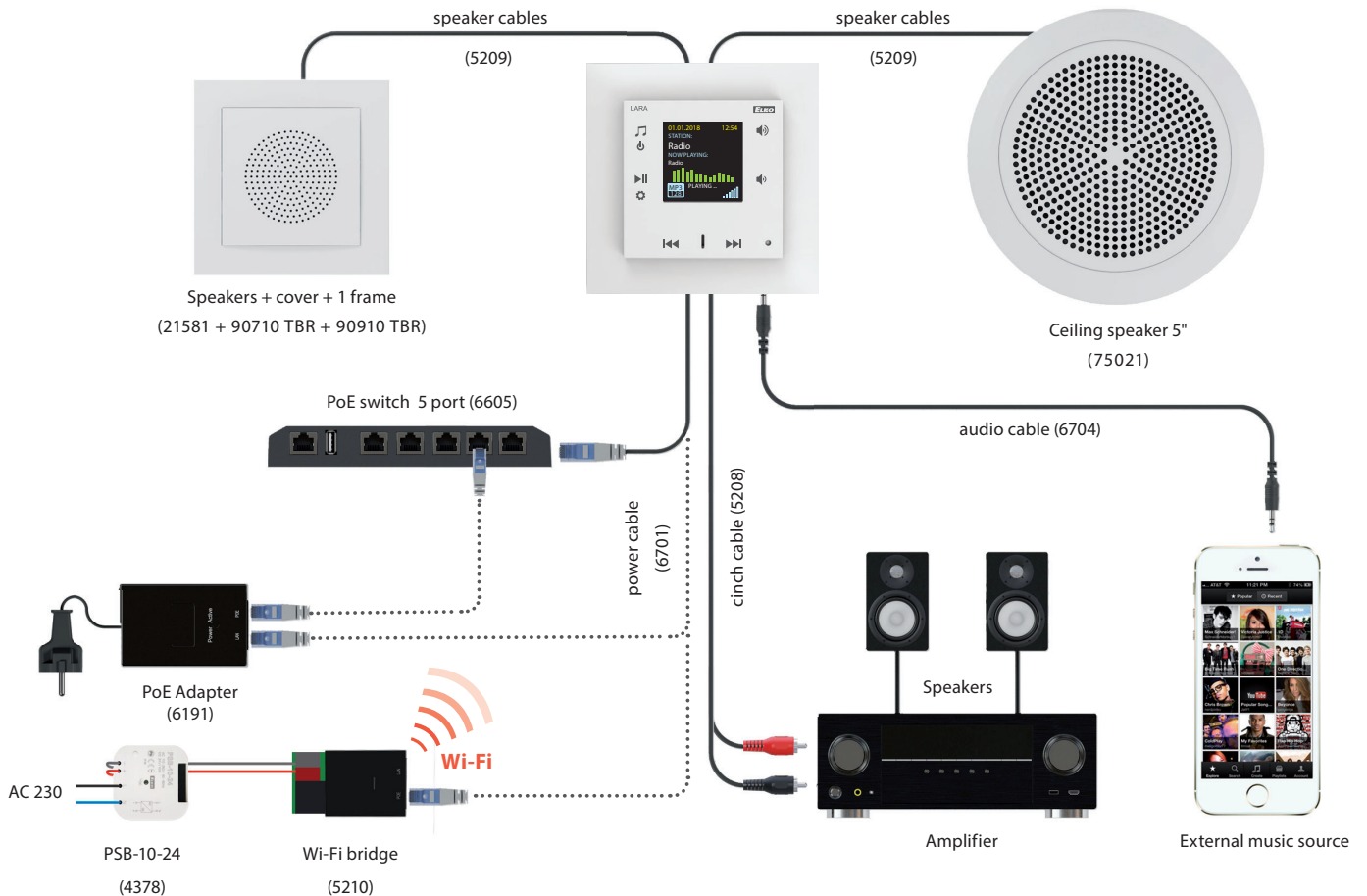

Wiring example







Speakers and cables

	<b>AUX CABLE LARA (LARA CINCH CABLE)</b> Used to connect LARA with exter. amplifier. Reduction 4pin from LARA LINE OUT to 2x CINCH plug into amplifier, length 2 x 20 cm.	5208
	<b>POWER SUPPLY (PSB-10-24)</b> Switching stabilized power supplies with fixed output voltage, intended for mounting into an installation box (e.g. KU-68). PSB-10-24 - stabilized power supply 24V/10 W.	4378
	<b>AUX CABLE LARA (LARA AUDIO CABLE)</b> Used to connect LARA with external music source (smart phone mp3 player). The length is 20 cm terminated with 2x stereo jack 3.5 mm.	6704
	<b>CEILING SPEAKER</b> Speaker is suitable for the installation in suspended ceilings and hollow walls. Mounting hole diameter 143 mm, Power 8 W, 32 Ω speaker impedance.	75021 CBR
	<b>SURFACE SPEAKER</b> Two-way speaker intended for mounting in a ceiling or on the walls: Power 15 W, 32 Ω speaker impedance, dimensions 270x183x37 mm. Color: White	75106 CBR
	<b>NETWORK CABLE, 0.2 m</b> Flat white LAN cable CAT5, length 20 cm, terminated with 2x RJ45 plugs.	6702
	<b>NETWORK CABLE, 1 m</b> Flat white LAN cable CAT5, length 1 m, terminated with 2x RJ45 plugs.	6700

Power supply and network

	<b>WI-FI BRIDGE</b> Used for LARA wireless connection via WiFi network.	5210
	<b>PoE SWITCH - 5x RJ45</b> Provides LAN connectivity and PoE power supply for up to 5 x LARA.	6605
	<b>PoE SWITCH - 8x RJ45</b> Provides LAN and connected PoE of up to 8x LARA. In addition to the 24 V PoE also offers a 48 V PoE for the power supply of 2N.	6606

Power sets

	<b>POWER SUPPLY PoE + WiFi INTO OR THE BOX</b> WiFi bridge with PoE and power supply into an installation box. Power supply 230 V.	5224
	<b>POWER SUPPLY PoE INTO A BOX</b> PoE injector with power supply intended for an installation box. Power supply 230 V.	5226
	<b>PoE SUPPLY</b> Power injector with plug-in adapter 230 V.	5225
	<b>POWER SUPPLY PoE + WiFi</b> WiFi bridge with PoE plug in adapter 230 V.	5227

Installation material



















	1-FRAME	90910 TBR
	2-FRAME	90920 TBR
	3-FRAME	90930 TBR
	4-FRAME	90940 TBR
	5-FRAME	90950 TBR
	SURFACE MOUNT BOX	10976 ABR
	INSTALLATION BOX 1 GANG (KP 67/2)	6705
	INSTALLATION BOX 2 GANG (KP 64/2)	6706
	INSTALLATION BOX 3 GANG (KP 64/3)	6707
	INSTALLATION BOX 4 GANG (KP 64/4)	6708
	INSTALLATION BOX 5 GANG (KP 64/5)	6709
	INSTALLATION BOX 1 GANG (KP 64/LD)	6710
	INSTALLATION BOX 2 GANG (KP 64/2L)	6711
	INSTALLATION BOX 3 GANG (KP 64/3L)	6712
	INSTALLATION BOX 4 GANG (KP 64/4L)	6713
	INSTALLATION BOX 5 GANG (KP 64/5L)	6714
	UNIVERSAL BOX 1068-02	6716
	UNIVERSAL BOX KUH 1/L NA	6717

The application allows easy control of connected devices through wireless and wired gateways, such as socket switching, dimming lights, controlling blinds or garage doors, managing heating circuits, and compatible air conditioning. It also displays available values, such as temperature, status of motion detectors, windows, doors, or flood detectors, as well as the current status of all controlled devices.

Newly, the application can be installed on tablets, where all control options are fully preserved, just like in the standard application. The user-friendly Dashboard on the tablet enables users to view frequently used devices, previews of connected cameras, and created scenes. Users can quickly and easily control multiple devices at once with a single click. Furthermore, it is now possible to integrate SIP-enabled Intercoms, allowing call notifications and door unlocking from anywhere in the world. Another new feature includes receiving notifications related to units connected to the account. With the new iNELS mobile application, we are opening a completely new stage, expanding the functions and integration possibilities of the iNELS system.

In addition to the iNELS mobile application, there is also the inels.cloud platform available. This website allows users to control devices connected to inels BUS and RF gateways through the cloud. The platform offers advanced features, including the ability to configure custom Dashboards, view historical device data, and conditionally interconnect RF and BUS units. This feature allows users to set conditions to respond to specific events or interconnect devices with each other. Another useful function is push notifications, which inform users about important events or device statuses. With the inels.cloud platform, user management is also possible, enabling account owners to add additional users and restrict their rights to control specific devices.

Thanks to these new updates and features, the iNELS mobile application and inels.cloud platform expand the possibilities and integration options of the iNELS system, providing users with an enhanced and seamless smart home experience.

Electroinstallation		
Wireless	BUS	
		Lighting control •
		Garage doors and gates •
		Switching appliances •
		RGB bulbs and LED strips •
		Scenes •
		Detectors/sensors •
		Heating •
		Air conditioning •
		Recuperation •
		Cameras •
		Weather station •
		Intercoms •
		Home appliances •
		Google Home •
		Amazon Alexa •
		Automation •
		Notification •
		Favourites/overview •
		Log history •
		Weather data •
		Users management •



## Conditions

Unlimited automation options.

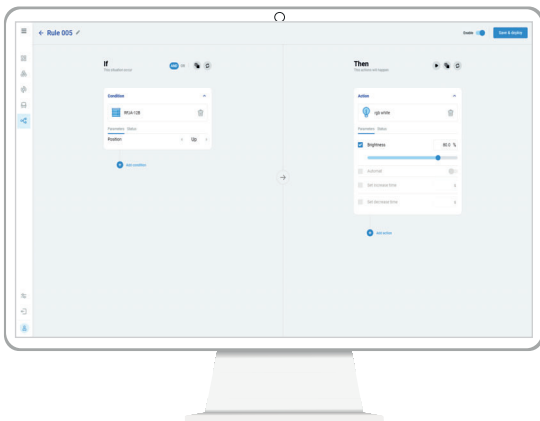

## User management

Control of user accounts.

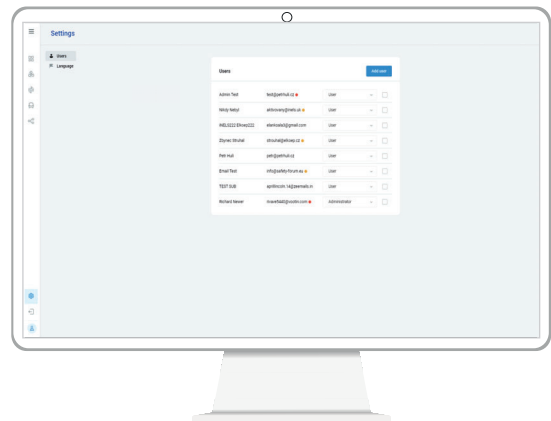

## Dashboard

Device overview with the option to view event history.

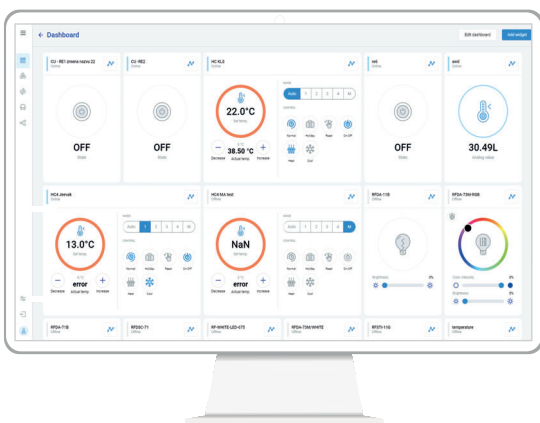

## Scenes

Group device control.

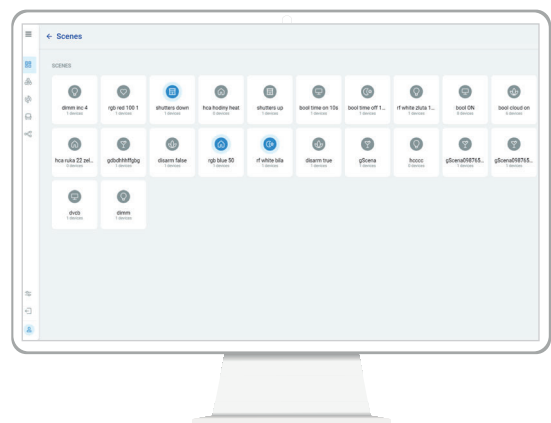

## Dashboard

Absolute control over the state of all technologies.



## Device list

Control the device from anywhere.

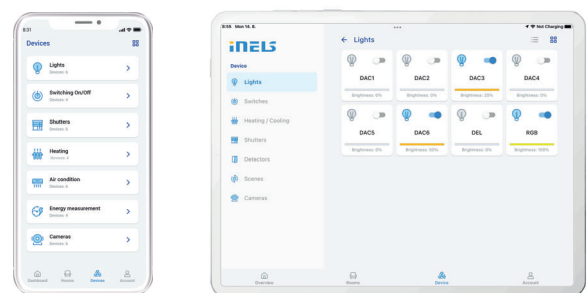

## Rooms management

Settings according to individual rooms.

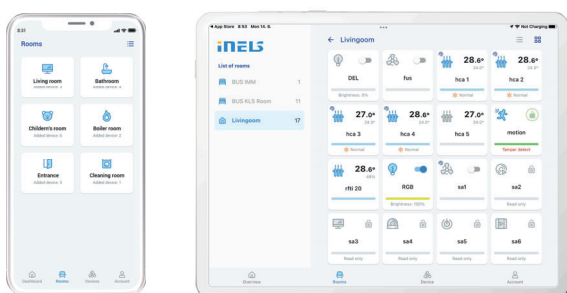

## Colour setting

Easy adjustment of the light scene with one touch - switching, dimming, colour.





EAN code  
 Telva-2 230V, NC: 8595188181976  
 Telva-2 230V, NO: 8595188181969  
 Telva-2 24V, NC: 8595188181990  
 Telva-2 24V, NO: 8595188181983

Technical parameters	TELVA 230V		TELVA 24V	
	NO	NC	NO	NC
Operating voltage:	230 V, 50/60 Hz		24 V, 50/60 Hz	
Switching current max:	300 mA		500 mA	
Operating current:	13 mA		100 mA	
Closing/opening time:	3–5 min		3–5 min	
Power input:	2.9 W		2.4 W	
Protection:	IP54		IP54	
Settings:	4 mm (0.16")		4 mm (0.16")	
Stopping force:	90–110 N		90–110 N	
Cable length:	800–1000 mm (31–39")		800–1000 mm (31–39")	
Connecting wire:	2 x 0.75 mm <sup>2</sup>		2 x 0.75 mm <sup>2</sup>	
Media temperature:	-5 °C to 60 °C (23 to 140 °F)		-5 °C to 60 °C (23 to 140 °F)	
Colour:	white RAL 9003		white RAL 9003	
Dimensions h/w/d:	63 x 42 x 45 mm (2.5 x 1.7 x 1.8")		63 x 42 x 45 mm (2.5 x 1.7 x 1.8")	
Connection size:	M30 x 1.5 mm (1.2" x 0.06")		M30 x 1.5 mm (1.2" x 0.06")	

- Thermdrive is intended for opening or closing valves in heating, cooling or air conditioning systems. It is also suitable for use in a floor heating or ceiling cooling manifolds.
- Available in NO (open without voltage), NC (closed without voltage) and for 230 V and 24 V.
- The internal principle of operation of thermdrive mechanism = its movement so that the valve opens/closes is provided by an electric heating element with expansion material, which expands due to temperature changes in the supply voltage.
- Thermdrive is maintenance-free and works completely silently.
- Thermdrive is fitted with a metal nut M30 x 1.5, thanks to which it becomes a 100% fixed part of the valve with this corresponding thread size after installation.
- The stated nut size predetermines the use of a thermocouple with valves from manufacturers such as Herz, HoneyWell, Danfoss, Oventrop and others.

#### • Telva thermo drive:

- is characterized by absolutely quiet and maintenance-free operation
- is designed for installation - control of heating and cooling systems
- method of mounting the actuator on the controlled valve using an M30 x 1.5 nut
- any working position

#### • Type of use:

- Floor heating – the RFTC-50/G wireless controller measures the room temperature and, based on the set program, sends a command to the RFSA-66M switching element to open/close the TELVA thermo drive on the distributor.

## AN-I | Internal antenna



- into plastic switchboard
- rod angle, without cable
- sensitivity 1 dB
- the internal antenna is included in the standard package

EAN code  
 Internal antenna AN-I: 8595188161862

## AN-E1 | External antenna



- for mounting into metal switchboard
- cable length 3m
- sensitivity 5 dB
- the external antenna AN-E is supplied on request only

EAN code  
 External antenna AN-E: 8595188190121



EAN code			
TC-0:	8595188110075	TZ-0:	8595188110591
TC-3:	8595188110617	TZ-3:	8595188110600
TC-6:	8595188110082	TZ-6:	8595188110594
TC-12:	8595188110099	TZ-12:	8595188110587
Pt100-3:	8595188136136	Pt100-6:	8595188136143
Pt100-12:	8595188136150		

- Thermister temperature sensors are made of Negative Temperature Coefficient (NTC) embedded in a PVC or metal sleeve with a thermally-conductive sealer.
- **Sensor TC**
  - lead-in cable to sensor TC is made of wire CYSY 2D x 0.5 mm/0.02".
- **Sensor TZ**
  - cable VO3SS-F 2D x 0.5 mm/0.02" with silicone insulation for use in high temperature applications.
  - silicone insulation for use in high temperature applications.
- **Sensor Pt100**
  - shielded silicon 2x 0.22 mm<sup>2</sup> (AWG 21), shielding connected with a case.
- temperature sensors can be connected directly to the terminal block
- cable lengths can not be changed, connected or modified.

Technical parameters	TC	TZ	Pt100
Range:	-20 to +80 °C	-40°C to +125 °C	-30°C to +200 °C
Scanning element:	NTC 12K	NTC 12K	Pt100
Tolerance:	±(0.15 °C + 0.002[t])	±(0.15 °C + 0.002[t])	±(0.3 °C + 0.005[t])
In air/in water:	(τ0.5) ≤ 18 s	(τ65) 62 s/8 s	(τ0.5) -/7 s
In air/in water:	(τ0.9) ≤ 48 s	(τ95) 216 s/23 s	(τ0.9) -/19 s
Cable material:	PVC unshielded, 2x 0.25 mm <sup>2</sup>	PVC	shielded silicone 2 x 0.22 mm <sup>2</sup>
Terminal material:	polyamid	stainless steel	copper
Protection degree:	IP67	IP67	IP67
Electrical strength:	2500 VAC	2500 VAC	2500 VAC
Insulation resistance:	> 200 MΩ at 500 VDC	> 200 MΩ at 500 VDC	> 200 MΩ at 500 VDC

Resistive values of sensors in dependance on temperature

Temperature (°C)	Sensor NTC (kΩ)	Sensor Pt100 (Ω)
20	14.7	107.8
30	9.8	111.7
40	6.6	115.5
50	4.6	119.4
60	3.2	123.2
70	2.3	127.1

Tolerance of sensor NTC 12 kΩ is ± 5% by 25 °C/77 °F.  
 Long-term resistance stability by sensor Pt100 is 0.05% (10 000 hours).

Types of temperature sensors:

	TC-0	TZ-0	-
- length:	100 mm	110 mm	-
- weight:	5 g	4.5 g	-
	TC-3	TZ-3	Pt100-3
- length:	3 m	3	3 m
- weight:	70 g	106 g	68 g
	TC-6	TZ-6	Pt100-6
- length:	6 m	6 m	6 m
- weight:	130 g	216 g	149 g
	TC-12	TZ-12	Pt100-12
- length:	12 m	12 m	12 m
- weight:	250 g	418 g	249 g

τ65 (95): time, which sensor needs to heat up on 65 (95) % of ambient temperature of environment, in which is located.

Diagramm of sensor warm up via air

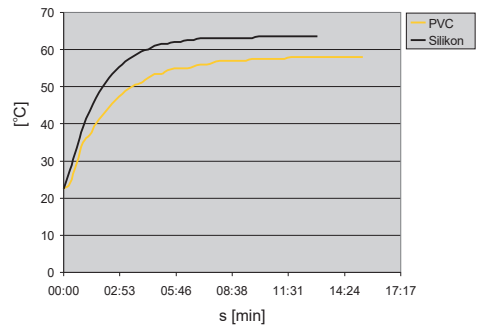

PVC - reaction to water temperature from 22.5 °C to 58°C.  
 Silicone - reaction to water temperature from 22.5°C to 63.5°C.

Sensor photo

TC



TZ



Pt100



Drawing

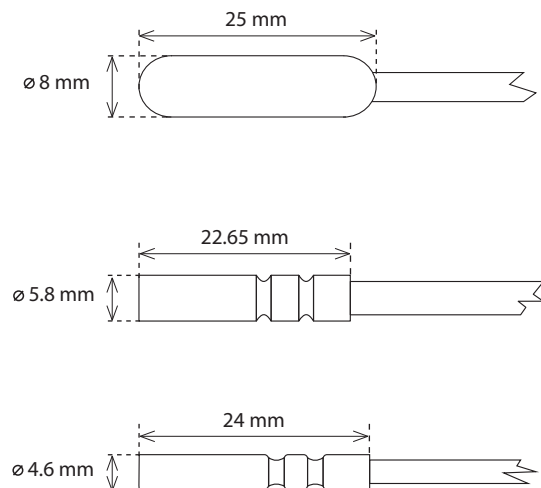



The BUS electro installation iNELS BUS System is a unique solution for electrical installation in the implementation of new projects of houses, villas, apartment buildings, office buildings, hotels, restaurants, wellness centres or perhaps even warehouse or production hall.

The ability to deploy this solution in such a wide variety of different buildings with various purposes and uses lies in its modularity. Thanks to the modular design, the system is very flexible and allows on the one hand, a solution of single-purpose tasks such as control of lighting in restaurants, and on the other hand, solving complex control systems for heating, ventilation, cooling, lighting and shading of office buildings. A complete range of control units designed from glass for management of hotel rooms is in the market unique. Thanks to its modularity is very easy to customize the size of the system and to that effect create a cost effective solution. Smart homes and buildings are accompanied by three basic ideas, namely savings, comfort and safety, the first two ideas may at first glance contradict each other. However, the main objective of smart home or building

equipped with the iNELS solution is to attain the optimum indoor environment while achieving the most efficient operation of all system. In homes and buildings the optimal internal environment is very important because people nowadays spend up to 80% of their time inside buildings. It is also shown that indoor environments, where we talk about thermal comfort, lighting comfort and indoor air quality significantly affect the mood and the effectiveness of people.

The iNELS system allows connection of wide range of sensors (temperature, light intensity, carbon dioxide, humidity, and pressure) and detectors (movement, opening doors and windows, gas leakage, smoke, flooding) whose values are constantly evaluated. At the same time iNELS allows the connection of all the technologies that are installed in the building, which continued to significantly increase operational efficiency or comfort, for example; in the case of integrating the guest room management system with the receptionist Fidelio system, which automatically during check-in, sends the room requests for execution, a welcome scene (optimum temperature, comfortable lighting scene, music etc.).

### More systems can be controlled by iNELS:



WSB3-40

Push-button wall controller



GSB3-40

Glass wall controller



GRT3-70

Temperature control



iNELS Cloud



Smartphone

#### What are the benefits of BUS controlling?

- Save energy by regulating lighting and heating properly
- Control of blinds, awnings, exterior or internal window shutters
- Dimming lights, lighting scenes
- Control of appliances or electrical devices
- Control access gates, garage doors
- Logical and central functions (exit button, ...)
- Manual and automatic control mode
- Preventing undesirable opening of a window or a door
- Responding to the movement of people (authorized and unauthorized)
- Remote monitoring via smartphone, tablet or laptop
- Possibility to control via the iNELS Touch Panel 10"
- Integration of third-party devices (cameras, air conditioning, ...)



Problematic choice of suitable relay contact for a particular load switched with a product is described below. Mostly we experience problems with incorrect choice of load (meaning incorrect relay for a particular load) which results in permanent switching of contact (sealing) or damage on relay contact – which then results in malfunction. What load can you use? Detailed types of load according to standard EN 60947 are described in charts below – categories of use.

Category of use	Typical use	EN
AC current, $\cos\phi = P/S$ (-)		
AC-1	Non-inductive or slightly inductive load, resistance furnace Includes all appliances supplied by AC current with power factor ( $\cos\phi$ ) $\geq 0.95$ Examples of usage: resistance furnace, industrial loads	60947-4
AC-2	Motors with slip-ring armature, switching off	60947
AC-3	Motors with short-circuit armature, motor switching when in operation This category applies to switching off motors with short-circuit armature while in operation. While switching, contactor switches current which is 5 up to 7 times rated current of motor.	60947-4
AC-4	Electro-motors with short-circuit armature: start up, braking by backset, changeover	60947
AC-5a	Switching of electrical gas-filled lights, fluorescent lights	60947-4
AC-5b	El. bulb switching Enables low contact loading due to resistance of cold fiber is many times smaller than the one of hot fiber.	60947-4
AC-6a	Switching of transformers	60947-4
AC-6b	Switching of capacitors	60947-4
AC-7a	Switching low inductive loads of home appliances and similar applications	60947
AC-7b	Load of motors for home appliances	60947
AC-8a	Switching of hermetically sealed motors of cooling compressors with manual reset switches against overload Hermetically sealed cooling compressors have to be placed in one box without external shaft or shaft padding and motor must operate with cooling liquid	60947
AC-8b	Switching of hermetically sealed motors of cooling compressors with manual reset switches against overload Hermetically sealed cooling compressors have to be placed in one box without external shaft or shaft padding and motor must operate with cooling liquid	60947
AC-12	Switching of semiconductor loads with separation transformers	60947-5
AC-13	Switching of semiconductor loads with separation transformers	60947-5-1
AC-14	Switching of low electro-magnetic loads (max.72 VA)	60947-5-1
AC-15	Management of alternating electro-magnetic loads This category applies to switching inductive loads with input for closed electro-magnetic circuit higher than 72 VA Use: switching coils of contactors	60947-5
AC-20	Connecting and disconnecting in unloaded states	60947-3
AC-21	Switching resistive loads, including low loading	60947-3
AC-22	Switching of mixed resistive and inductive loads, including low overloading	60947-3
AC-23	Switching of motor loads or other high inductive loads	60947-3
AC-53a	Switching of motors with short-circuit armature with semiconductor contactors	60947

Note: Category AC 15 replaces formerly used category AC 11

DC current,  $t = L/R$  (s)

DC-1	Non-inductive or low inductive load, resistive furnaces	60947-4
DC-3	Shunt motors: start-up, braking by backset, reversion, resistive braking	60947-4-1
DC-5	Series motor: start-up, braking by backset, reversion, resistive braking	60947-4-1
DC-6	Non-inductive or low inductive loads, resistive furnaces – el. bulbs	60947-4-1
DC-12	Management of resistive loads and fixed loads with insulation by opto-electric element	60947-5-1
DC-13	Switching of electromagnets	60947-5-1
DC-14	Switching of electromagnetic loads in circuits with limiting resistor	60947-5-1
DC-20a(b)	Switching and breaking without load(a: frequent switching ,b: occasional switching)	60947-3
DC-21a(b)	Switching ohmic loads including limiting overloading (a: frequent switching ,b: occasional switching)	60947-3
DC-22a(b)	Switching of compound ohmic and inductive loads including limited overloads (e.g. shunt motors) (a: frequent switching, b: random switching)	60947-3
DC-23	Switching of highly inductive loads (e.g. series motors)	60947-3

How can you distinguish for which load is our product (relay) designated?

Our company records this information on a products and also in our catalogue, instruction manual and other promotional and technical material (website etc.).

It is important to realize that it is not always possible to point out load because of lack of information about the device (user cannot measure  $\cos\phi$ ) or it is not possible because of inconsistency of parameters of switched device. Manufacturer of relays records always guaranteed parameters in ideal conditions which are done by a norm (temperature, pressure, humidity, etc.) and reality can be in a lot of cases different. Category of use (classification) of a particular relay is done by material of output contacts.

Basic types of materials which are used for production of contacts for high-performance relay are:

- AgCd – suitable for switching ohmic loads. Before of harmfulness of Cd, this type of contact is remitted.
- AgNi – designated for switching resistive loads, good quality switching and conducting (contact doesn't oxidate) small currents/voltages, it is not designated for surge currents and loads with inductive component.
- AgSn or AgSnO<sub>2</sub> – suitable for switching loads with inductive component, not suitable for switching small currents/voltages, it is more resistive to surge currents, suitable for DC voltage switching, less suitable for switching loads of ohmic type.
- Wf (wolfram)-special contact designated for switching surge currents with inductive component.
- with gold (AgNi/Au)- Used for "improving" contacts for low currents/ voltages , prevents oxidation.



















## Minimum load

Relay contact	mV	V/mA
AgSnO <sub>2</sub>	1000	10/100



















## Minimum load

Relay contact	mV	V/mA
AgNi	300	5/10



















## GCR3-11, GCH3-31, SA3-02B, SA3-06M, WMR3-21, SA3-014M, JA3-014M, RC3-610M/DALI, IOU3-108M

Type of load	 cos φ ≥ 0.95								
Contact material	AC1	AC2	AC3	AC5a uncompensated	AC5a compensated	AC5b	AC6a	AC7b	AC12
AgSnO <sub>2</sub> contact 8 A	250 V/8 A	250 V/2.5 A	250 V/1.5 A	230 V/1.5 A (345 VA)	230 V/1.5 A (345 VA) till max output C=14uF	250 W	X	250 V/1 A	250 V/1 A
Type of load									
Contact material	AC13	AC14	AC15	DC1	DC3	DC5	DC12	DC13	DC14
AgSnO <sub>2</sub> contact 8 A	250 V/3 A	250 V/3 A	250 V/3 A	24 V/4 A	24 V/2 A	24 V/1.5 A	24 V/4 A	24 V/1 A	24 V/1 A



















## SA3-04M, SA3-022M (RE7 - RE-10), SA3-01B

Type of load	 cos φ ≥ 0.95								
Contact material	AC1	AC2	AC3	AC5a uncompensated	AC5a compensated	AC5b	AC6a	AC7b	AC12
AgSnO <sub>2</sub> contact 16 A	250 V/16 A	250 V/3 A	250 V/2 A	230 V/3 A (690 VA)	230 V/3 A (690 VA) till max output C=14uF	1500 W	x	250 V/3 A	250 V/10 A
Type of load									
Contact material	AC13	AC14	AC15	DC1	DC3	DC5	DC12	DC13	DC14
AgSnO <sub>2</sub> contact 16 A	250 V/6 A	250 V/6 A	250 V/6 A	24 V/8 A	24 V/4 A	24 V/3 A	24 V/8 A	24 V/2 A	24 V/2 A





## SA3-02B/Ni\*, SA3-06M/Ni\*

Type of load	 cos φ ≥ 0.95								
Contact material	AC1	AC2	AC3	AC5a uncompensated	AC5a compensated	AC5b	AC6a	AC7b	AC12
AgNi contact 8 A	250 V/8 A	250 V/1.5 A	250 V/1 A	230 V/1.5 A (345 VA)	x	400 W	x	250 V/0.5 A	250 V/5 A
Type of load									
Contact material	AC13	AC14	AC15	DC1	DC3	DC5	DC12	DC13	DC14
AgNi contact 8 A	250 V/2 A	250 V/2 A	250 V/2 A	24 V/4 A	24 V/2 A	24 V/1.5 A	24 V/4 A	24 V/1 A	24 V/0.5 A

## SA3-06M/Ni\*, SA3-04M/Ni\*







Type of load	 cos φ ≥ 0.95								
Contact material	AC1	AC2	AC3	AC5a uncompensated	AC5a compensated	AC5b	AC6a	AC7b	AC12
AgNi contact 16 A	250 V/16 A	250 V/2.25 A	250 V/1.5 A	230 V/3 A (690 VA)	x	800 W	x	250 V/1 A	250 V/10 A
Type of load									
Contact material	AC13	AC14	AC15	DC1	DC3	DC5	DC12	DC13	DC14
AgNi contact 16 A	250 V/4 A	250 V/4 A	250 V/4 A	24 V/8 A	24 V/4 A	24 V/3 A	24 V/8 A	24 V/2 A	24 V/1 A

SA3-022M (RE1 - RE6, OUT1 - OUT2, RE11 - RE16, SHUTTER),  
EA3-022M (RE1 - RE6, OUT1 - OUT2, RE11 - RE16, SHUTTER),  
FA3-612M (FAN1 - FAN3, RE)













Type of load	 cos φ ≥ 0.95			
Contact material	AC1	AC3	AC15	DC1
AgNi contact 6 A	250 V/6 A	230 V/0.8 A	230 V/1.3 A	30 V/3 A 110 V/0.2 A 220 V/0.12 A

Demonstrated symbols are informative.

\*Products with AgNi contact only up on request for extra charge.

Load	bulbs, halogen bulbs	12–24 V low-voltage bulbs, coil transformers	12–24 V low-voltage bulbs, electric transformers	LEDs/LED strip*	energy-saving fluorescent tubes	control method	
							
	R	L	C	dimmable	dimmable	entering edge	trailing edge
DA3-22M	•	•	•	•	•	•	•
DA3-66M	•	•	•	•	•	•	•
DA3-03M/RGBW	-	-	-	•	-	-	-

Explanations

	<b>El. bulbs loads:</b> el. bulb, halogen light	(R)		Elektronic ballasts for fluorescent	(L)
	<b>Dimmer with defined load:</b> R - resistive, L - inductive, C - capacitive			<b>Inductive loads (transformers):</b> ferromagnetic and toroid transformers for lights with various voltage.	
	<b>Fluorescent light:</b> fluorescent lights uncompensated			<b>Switch:</b> switch - control contact of various device	
	<b>Fluorescent light:</b> fluorescent light compensated in series			<b>Button:</b> control button	
	<b>Fluorescent light:</b> fluorescent light compensated in parallel			<b>Control module:</b> analog control module 0 - 10 V	
	<b>Fluorescent light:</b> fluorescent light economical			Motor	

Category of use	Typical use
-----------------	-------------

AC current,  $\cos\varphi = P/S$  (-)

<b>AC-1</b>	Non-inductive or slightly inductive load, resistance furnace. Includes all appliances supplied by AC current with power factor ( $\cos \varphi$ ) $\geq 0.95$ . Examples of usage: resistance furnace, industrial loads.
<b>AC-2</b>	Motors with slip-ring armature, switching off.
<b>AC-3</b>	Motors with short-circuit armature, motor switching when in operation. This category applies to switching off motors with short-circuit armature while in operation. While switching, contactor switches current, which is 5 up to 7 times rated current of motor.
<b>AC-5a</b>	Switching of electrical gas-filled lights, fluorescent lights.
<b>AC-5b</b>	El. bulb switching. Enables low contact loading due to resistance of cold filament is many times smaller than the one of hot filament.
<b>AC-6a</b>	Switching of transformers.
<b>AC-7b</b>	Load of motors for home appliances.
<b>AC-12</b>	Switching of semiconductor loads with separation transformers.
<b>AC-13</b>	Switching of semiconductor loads with separation transformers.
<b>AC-14</b>	Switching of low electro-magnetic loads (max. 72 VA).
<b>AC-15</b>	Management of alternating electro-magnetic loads. This category applies to switching inductive loads with input for closed electro-magnetic circuit higher than 72 VA. Use: switching coils of contactors.

Note: Category AC 15 replaces formerly used category AC 11.

DC current,  $t = L/R$  (s)

<b>DC-1</b>	Non-inductive or low inductive load, resistive furnaces.
<b>DC-3</b>	Shunt motors: start-up, braking by backset, reversion, resistive braking.
<b>DC-5</b>	Series motor: start-up, braking by backset, reversion, resistive braking.
<b>DC-12</b>	Management of resistive loads and fixed loads with insulation by opto-electric element.
<b>DC-13</b>	Switching of electromagnets.
<b>DC-14</b>	Switching of electromagnetic loads in circuits with limiting resistor.

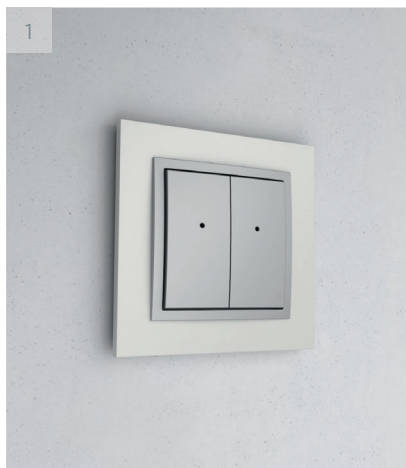

### 1) Surface mounted

Wall mounted in an installation box with spacing of 65 mm.

EST4	GSB3-40/S	WSB3-20H
EHT3	GSB3-60/S	WSB3-40
GBP3-60x	GSB3-90/S	WSB3-40H
GCR3-11	MSB3-40	
GCH3-31	MSB3-60	
GRT3-50	MSB3-90	
GSB3-40	GSP3-100	
GSB3-60	GCR3-30	
GSB3-80	IDRT3-1	
GSB3-90	WMR3-21	
GSB3-20/S	WSB3-20	

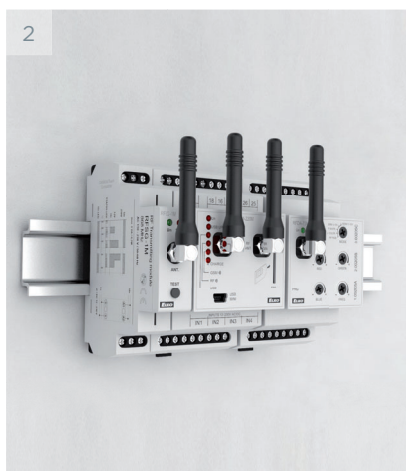

### 2) DIN Rail mounted

On DIN rail according to EN 60715.

ADC3-60M	PS3-100/iNELS
CU3-07M	SA3-04M
DA3-66M	SA3-06M
DA3-22M	SA3-014M
DAC3-04M	SA3-022M
FA3-612M	TI3-60M
IM3-140M	
IOU3-108M	
JA3-014M	
PS3-30/iNELS	

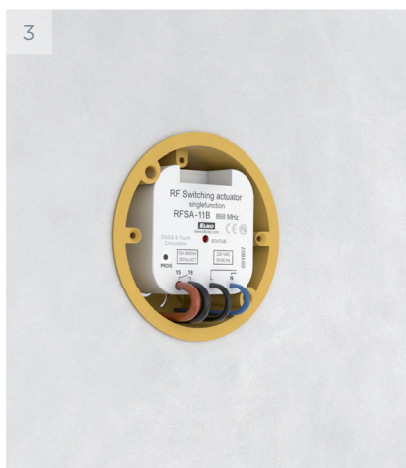

### 4) Mounted to or in the installation box

Mounted in an installation box or built into the device.

IM3-40B	SA3-01B
IM3-80B	SA3-02B
	TI3-40B



### 4) Mounted into the cover of appliance

SA3-01B
SA3-02B

5



### 5) Surface mounted

*Other attachment options.*

DLS3-1

6



### 6) Ceiling mounting

MCD3-01  
PMS3-01

1-MODULE

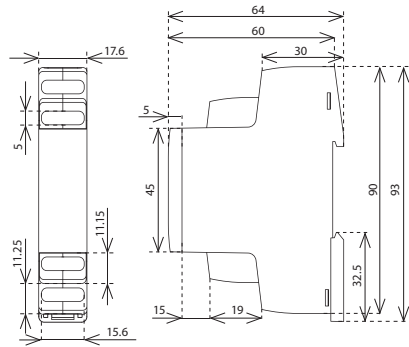

- BPS3-01M
- BPS3-02M
- CU3-07M
- CU3-08M
- CU3-09M/DALI
- CU3-10M
- iNELS Bridge

3-MODULE

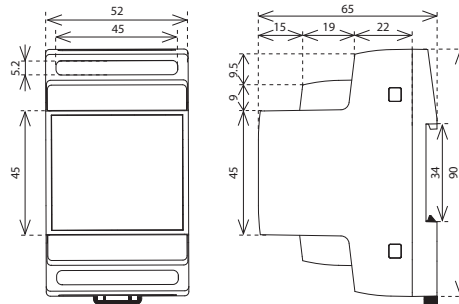

- ADC3-60M
- DA3-22M
- DAC3-04M
- IM3-140M
- PS3-30/iNELS
- SA3-04M
- SA3-06M
- TI3-60M
- DA3-03M/RGBW

6-MODULE

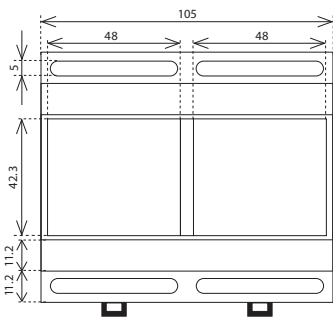

- DA3-66M
- EA3-022M
- FA3-612M
- IOU3-108M
- JA3-014M
- JA3-014M/E
- SA3-014M
- SA3-014M/E
- SA3-022M
- RC3-610M/DALI

BOX

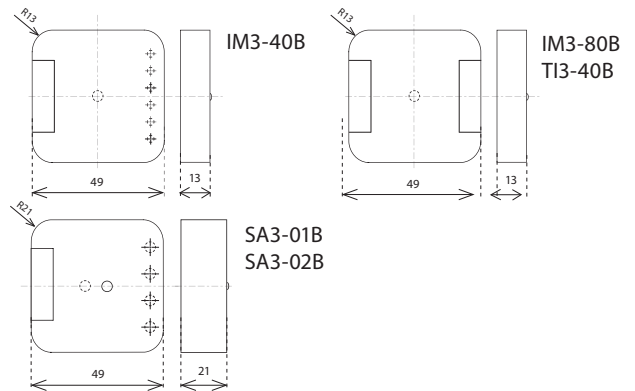

PSM3

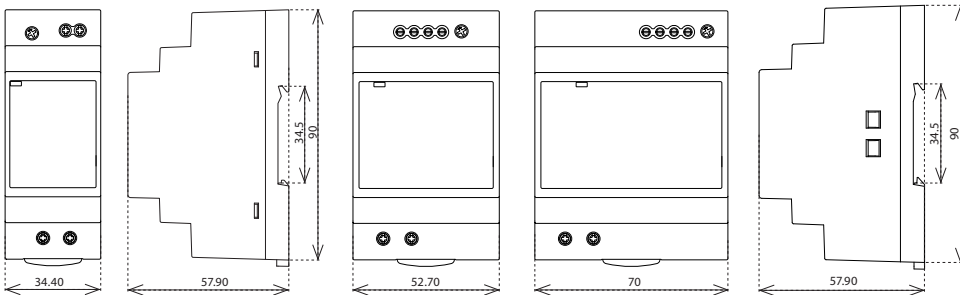

- PSM3-30
- PSM3-60
- PSM3-100

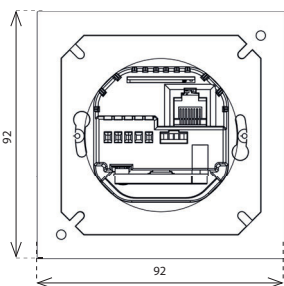

EST4

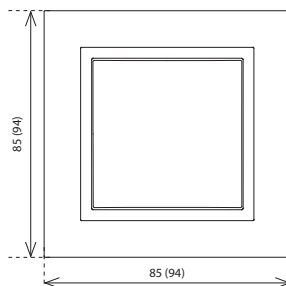

- WSB3-20
- WSB3-20H
- WSB3-40
- WSB3-40H
- WMR3-21

IDRT3-1

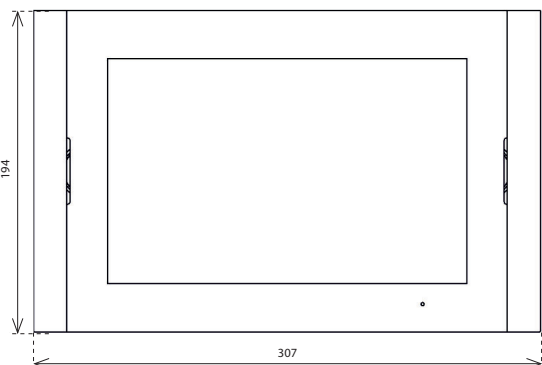

EST10

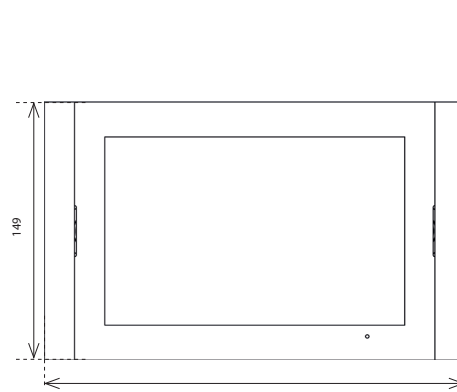

EST8

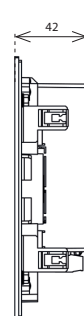

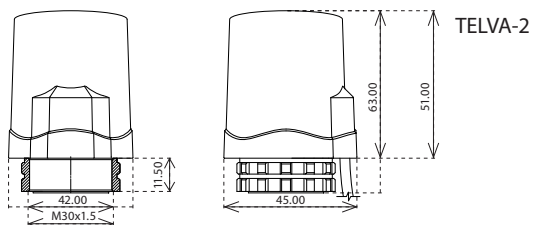
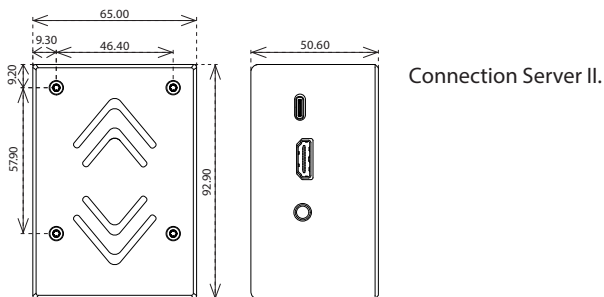
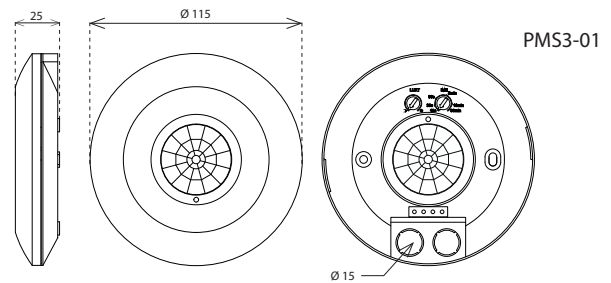
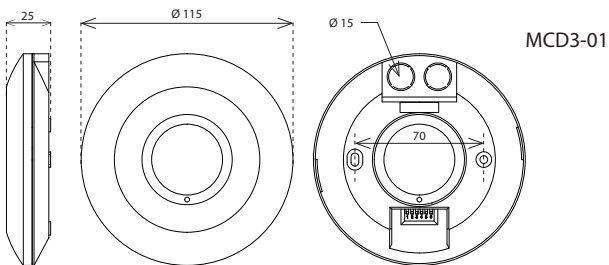
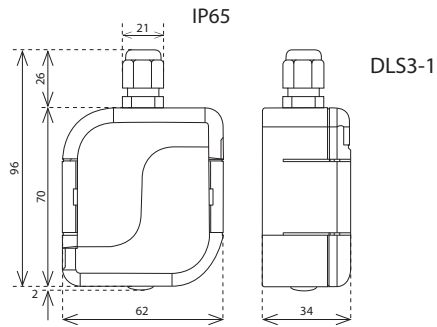
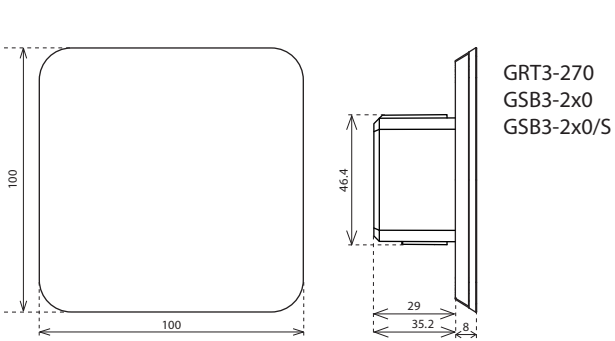
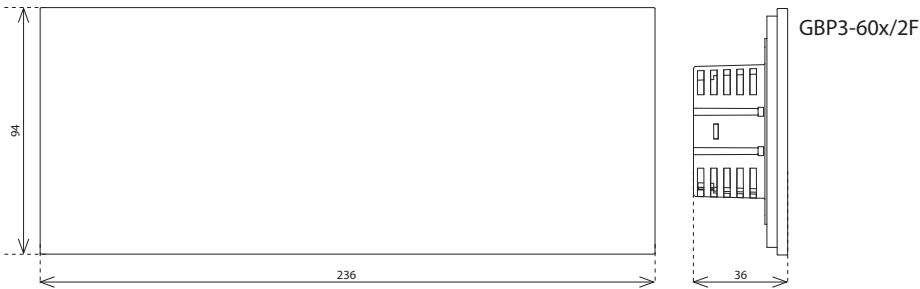
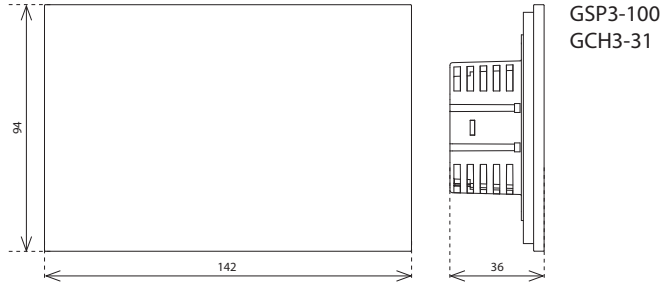
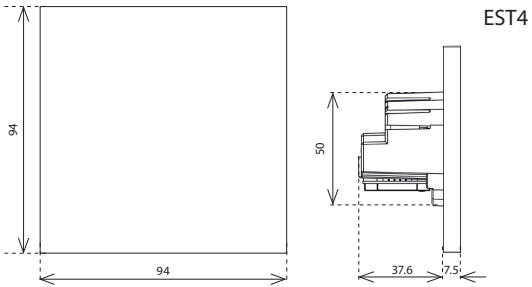
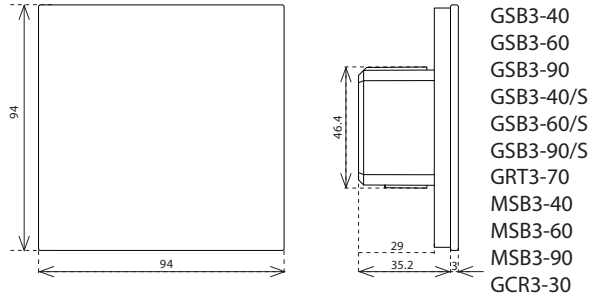
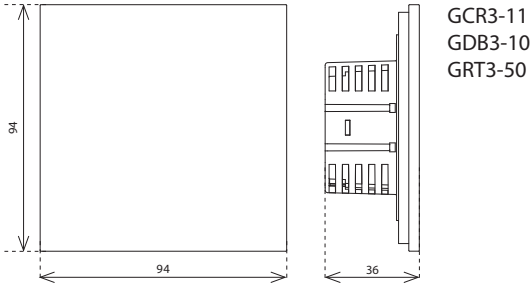



● **Headquarters**

ELKO EP Holding SE, Czech Republic

---

● **Europe**

ELKO EP Balkan d.o.o  
ELKO EP Bulgaria OOD  
ELKO EP Germany GmbH  
ELKO EP Hungary Kft.  
ELKO EP POLAND Sp. z o.o.  
ELKO EP SLOVAKIA, s.r.o.  
ELKO EP UK Ltd.  
ELKO EP UKRAINE LLC

● **Africa & Middle East**

ELKO EP Egypt LLC  
ELKO EP Kuwait Ltd.  
ELKO EP MEA LLC  
ELKO EP Saudi Arabia Ltd.  
ELKO EP South Africa PTY  
Ltd.

● **America**

ELKO EP North America LLC

---



**ELKO EP, s.r.o.** | Palackeho 493 | 769 01 Holesov, Vsetuly | Czech Republic  
phone: +420 573 514 221 | fax: +420 573 514 227 | [elko@elkoep.com](mailto:elko@elkoep.com) | [www.elkoep.com](http://www.elkoep.com)

Published: 01/2024 | Modifications or amendments reserved | © Copyright ELKO EP, s.r.o. | 1<sup>st</sup> edition