

# HOSPITALITY SOLUTION

for new & existing hotels



[www.inels.com/hotel](http://www.inels.com/hotel)







**ELKO EP have been your partner in the field for 30 years, developing and manufacturing the highest quality electronic devices for electroinstallation as well as Smart System for Residential and Building automation.**

ELKO EP employs more than 350 people across 11 foreign branches and exports its products to more than seventy countries. Company of the Year, Visionary of the Year, Superbrands and Global Exporter of the Year are just some of the awards we have received throughout the years as we consistently strive to move forward in the field of innovation and development.

Millions of relays, thousands of smart homes, hundreds of buildings and many satisfied customers - This is ELKO EP; a traditional company based in the center of Europe, where own development, production, logistics, and service are at the forefront of our focus.





**30 %**

Czech

**40 %**

export

**30 %**

branches



**WORLDWIDE**

11 branches  
6 franchises  
70 export countries

**350**

employees  
in holding

**30 000 +**

iNELS  
installations

**30 000 000 +**

manufactured  
products

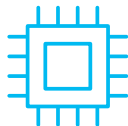

**R&D**

continuously  
innovative

**MANUFACTURER**

fully automated  
complete proces

**SUPPORT**

24 / 7 / 365

**World leader**  
in DIN rail relays production

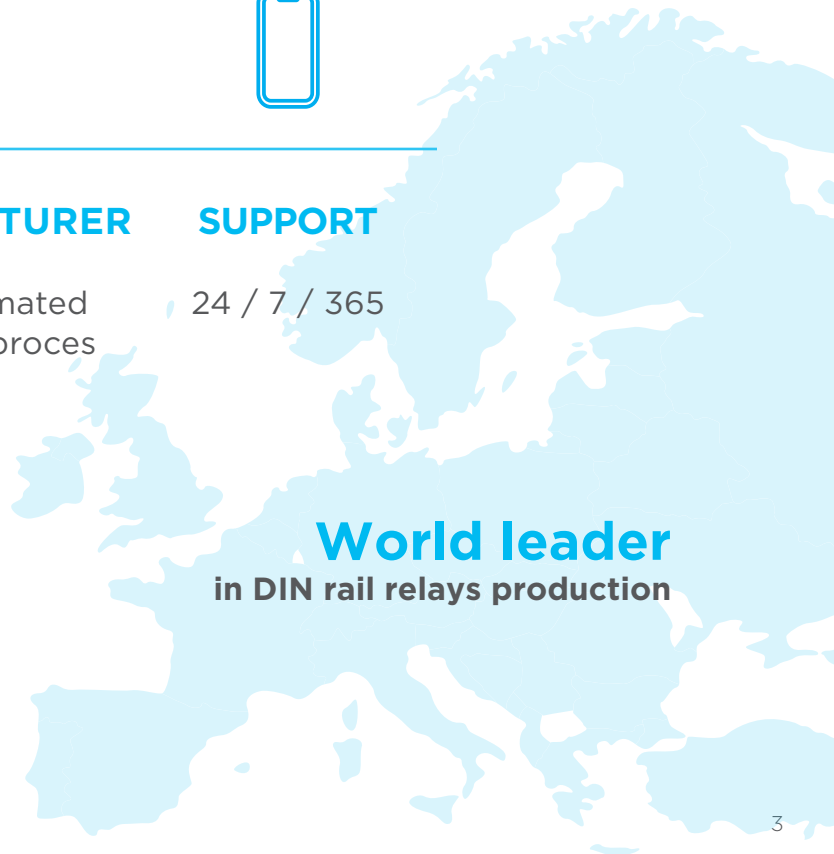



## You'll feel right at home

**ELKO EP develops and supplies the third generation iNELS Hospitality system - which means a system according to the latest trends and requirements for design and function. The iNELS GRMS bus system is designed for new hotel rooms and the iNELS HRESK wireless system for existing hotel rooms and retrofits.**

Regardless of whether it is a new or existing room, the iNELS system offers unlimited possibilities to configure functions and devices in the hotel room. It is not only possible to customise the design of the controllers to the interior of the room, choosing plastic or natural frames from the wide range of Logus90 or directly selecting glass or metal controllers.



### Savings

The occupancy presence function ensures that all the lights are switched off and the temperature is reduced to energy-saving mode. This can achieve unprecedented savings throughout the hotel.



### Automation

Functions happen automatically in the background without disturbing the guest. An open window sensor blocks the thermostat, a PIR detector controls lighting and temperature.



### Design

Whether you choose from the range of natural Logus frames, quality glass panels or luxurious metal buttons, you'll always have the option of colour combinations.





## Customization

Thanks to direct source from the manufacturer, you can define colours, shapes, icons or button text, including your hotel logo. We can also prepare factory pre-programmed packages for plug and play use.



## Integration

Cooperation with door locks and hotel reception software is a matter of course. Information about room occupancy, service or cleaning requests is exchanged. Everything happens automatically.



## Versatility

iNELS Hospitality is suitable for all types of hotels, regardless of the number of stars. It can be conveniently expanded or changed at any time. The wireless and fieldbus systems interact with each other.



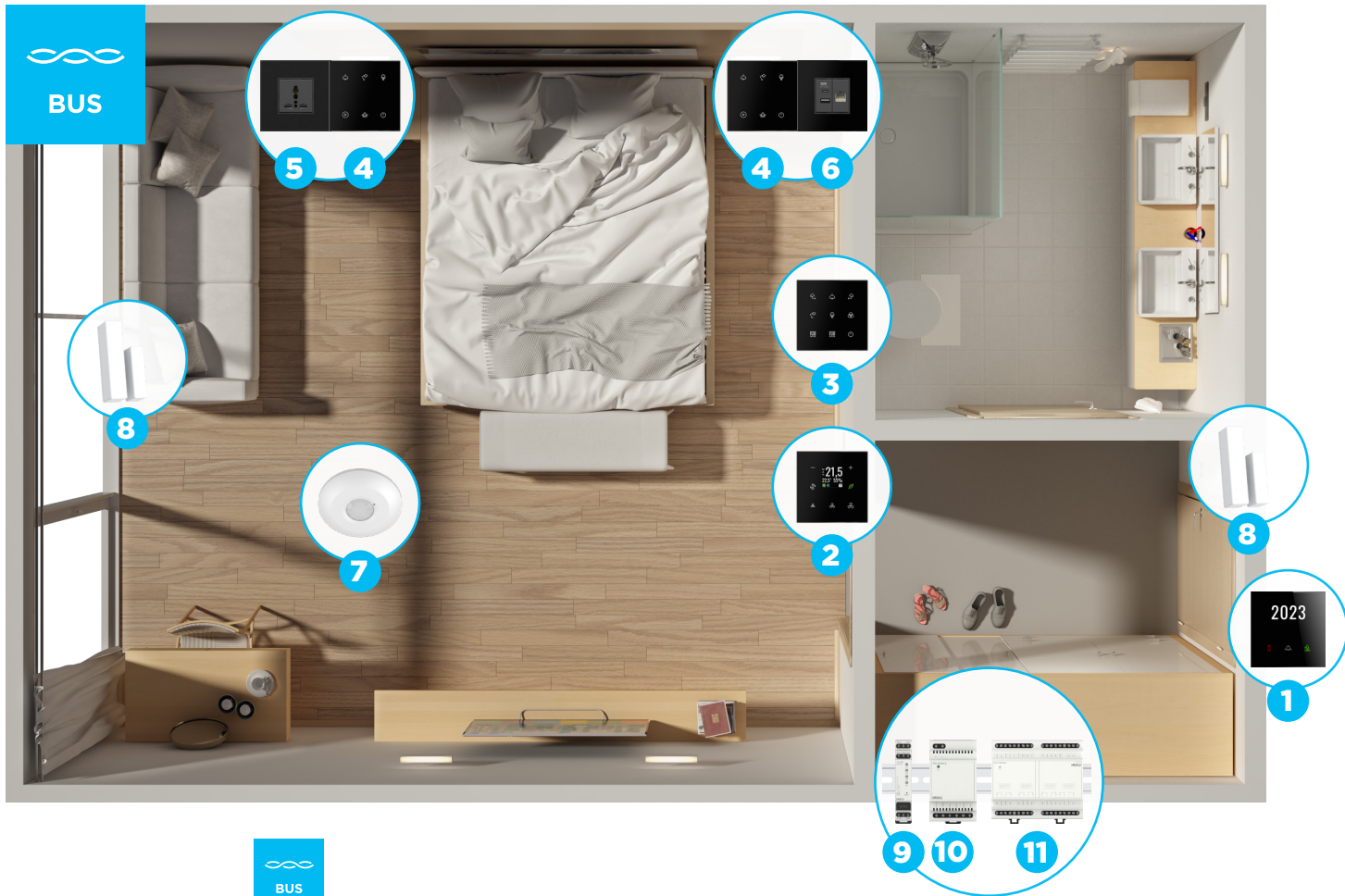

|                    |   |
|--------------------|---|
| <b>Control</b>     | • |
| Lighting           | • |
| Temperature        | • |
| Access             | • |
| Curtains           | • |
| Courtesy           | • |
| Audio              | • |
| TV integration     | • |
| Occupancy          | • |
| <b>Controllers</b> | • |
| Plastic            | • |
| Glass              | • |
| Metall             | • |
| Touch              | • |
| <b>Integration</b> | • |
| PMS                | • |
| HRS                | • |
| iNELS App          | • |
| Access/Lockers     | • |

- 1** Glass card reader  
GCR3-30
- 2** Glass room thermo-regulator  
GRT3-70
- 3** Glass switch panel - 9 buttons  
GSB3-90S
- 4** Glass switch panel with symbols - 6 buttons  
GSB3-60/S
- 5** AC power multistandard socket  
GSS3-PMS
- 6** USB/LAN socket panel  
GSS3-USB/LAN
- 7** Ultra slim PIR motion detector  
PMS3-01
- 8** Door/window wired contact
- 9** Central unit  
CU3-10M, MODBUS & MQTT gateway
- 10** Power supply  
PS3-30/iNELS
- 11** Room controller with DALI dimmer  
RC3-610M/DALI

DIN RAIL PANEL



# EXISTING ROOM - Hotel Room Retrofit (HRESK)



WIFI/MQTT  
to PMS

|                    |   |
|--------------------|---|
| <b>Control</b>     | • |
| Lighting           | • |
| Temperature        | • |
| Access             | • |
| Curtains           | • |
| Courtesy           | • |
| Audio              | - |
| TV integration     | • |
| Occupancy          | • |
| <b>Controllers</b> | • |
| Plastic            | • |
| Glass              | • |
| Metall             | x |
| Touch              | • |
| <b>Integration</b> | • |
| PMS                | • |
| HRS                | • |
| iNELS App          | • |
| Access/Lockers     | • |

- 1 Infront of door hotel room unit  
RFBS-30/S, 24V/230V powered
- 2 Glass touch controller with symbols  
RFSW-62/S, 24V/230V powered, MQTT gateway included
- 3 Glass touch thermostat for fancoils  
RFTC-3, 230V powered
- 4 Motion detector for ceiling mounting  
RFMD-200, battery powered
- 5 Window/door detector  
RFWD-100, battery powered
- 6 Glass touch controller, 4 buttons  
RFGB-40, battery powered
- 7 Switch unit, 2 channels  
RFSAI-62B-SL, 230V powered
- 8 DALI controller, 4 DALI balast  
RFDALI-04/B-SL, 230V powered

Look how HRESK works



## Classic with a touch of nature

The WSB3 full-screen pushbutton controllers bring a wide range of colour and frame material combinations from the Logus90 range. Whether you choose a completely classic white plastic frame, a pastel-coloured Animato frame or a glass, wood, metal or stone frame, there is always a fingerboard in a matching colour to go with your chosen frame.



- Base**  
(plastic)
- Animato**  
(plastic)
- Crystal**  
(glass)
- Metallo**  
(metal)
- Arbore**  
(wood)
- Petra**  
(stone)

LOGUS<sup>90</sup>





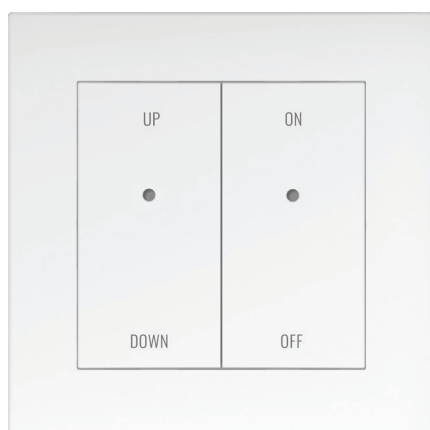
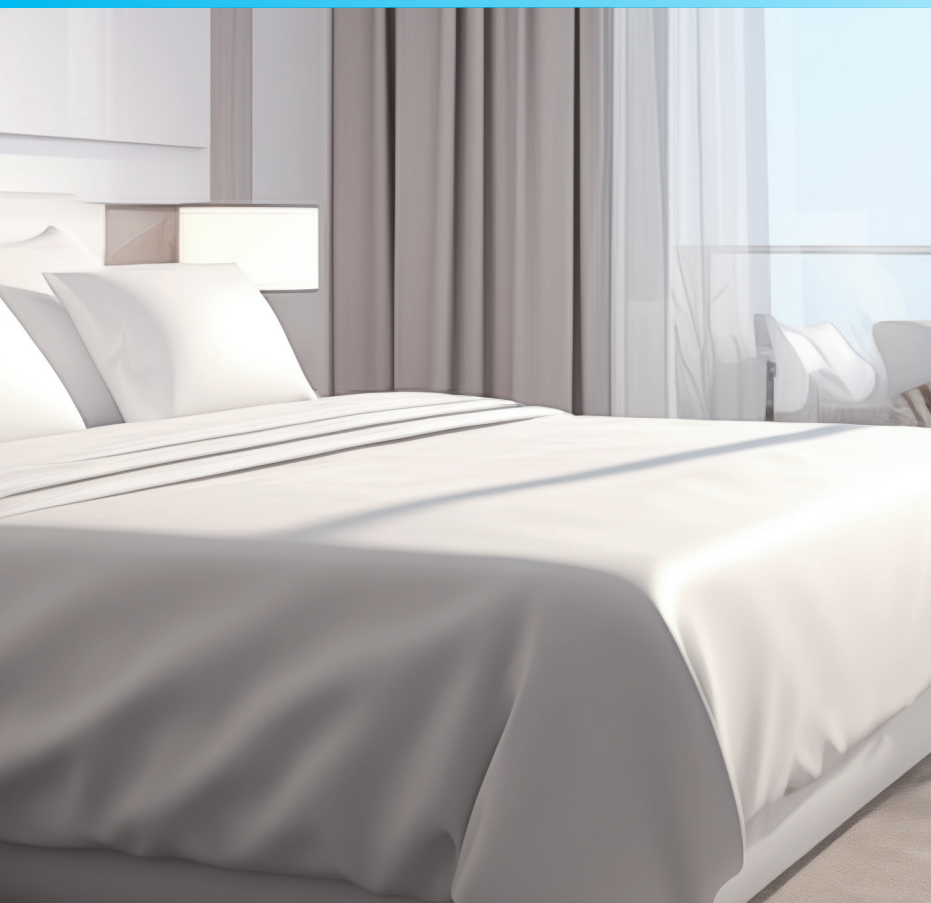

2 and 4 button versions are available, equipped with a two-colour signal LED whose function can be defined in software. The drivers include a temperature and humidity sensor as well as an input for an external wire contact or temperature sensor.

## Design & Function in one controller

Glass panels stand out in any interior - even in a hotel or at home. Whether round or sharp, in black or white glass, there are always 4, 6 or 9 buttons available. The buttons are backlit, and the colours and brightness of the backlight can be set by software, as can the acoustic signal when pressed.

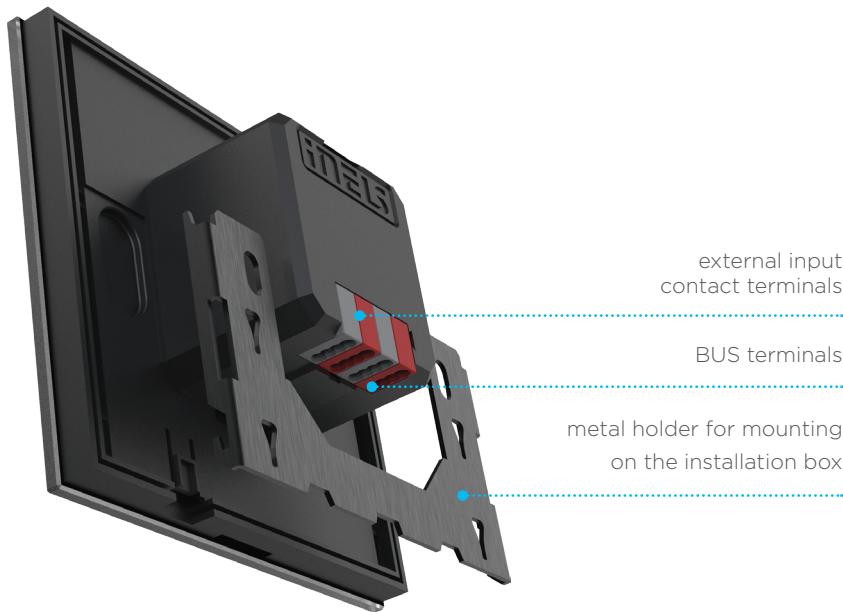

### GSB3-XXX/SXX

- P - proximity sensor
- B - black glass  
W - white glass
- S - symbols
- 40 - 4 buttons  
60 - 6 buttons  
90 - 9 buttons
- ( ) - sharp  
2 - round
- Glass Switch Button







Black round glass / 4 buttons



Black sharp glass / 6 buttons

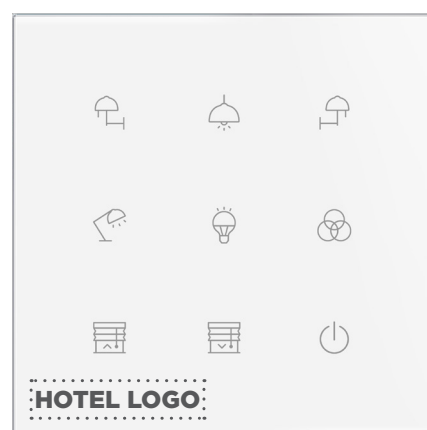

White Sharp Glass / 9 buttons

Any icon and text description can be applied to the button position (see [icons.inels.com](https://icons.inels.com) configurator). The glass control panels contain temperature and humidity sensors as standard. SWP/SBP versions also include a proximity and ambient light sensor, which allows the backlight to be activated in the dark and then does not disturb the guest at night. In addition, each panel is equipped with an external input for connecting a wired contact or temperature sensor.

Make your design:  
**[icons.inels.com](https://icons.inels.com)**

## Luxury without compromise

The new range of metal control panels combines the luxury of metal surfaces with the elegance of a classic button press. Four finishes are available - for both panels and buttons: Brushed Silver, Satin Brass, Antique Copper or Graphite Black.

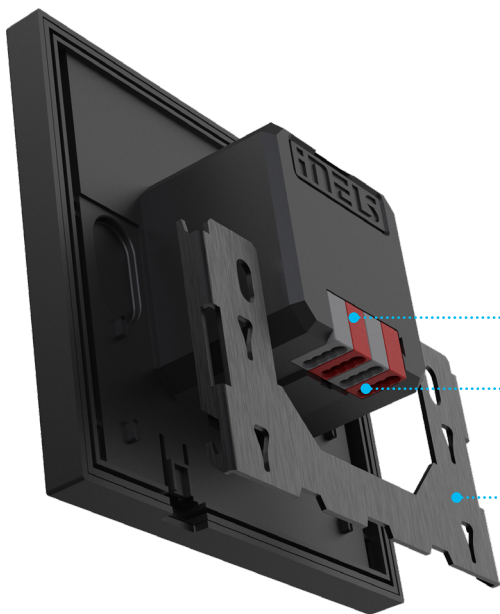

external input  
contact terminals

BUS terminals

metal holder for  
installation on the fixing box

### MSB3-XX/SS

- **Button finishes:**
  - G** - Satin brass
  - B** - Graphite black
  - S** - Brushed silver
  - C** - Antique copper
- **Plate finishes:**
  - G** - Satin brass
  - B** - Graphite black
  - S** - Brushed silver
  - C** - Antique copper
- **40** - 4 buttons
- **60** - 6 buttons
- **90** - 9 buttons
- **Metal Switch Button**



White LED backlight

light sensors

Antique Copper  
/ 9 buttons





Brushed Silver / 4 buttons

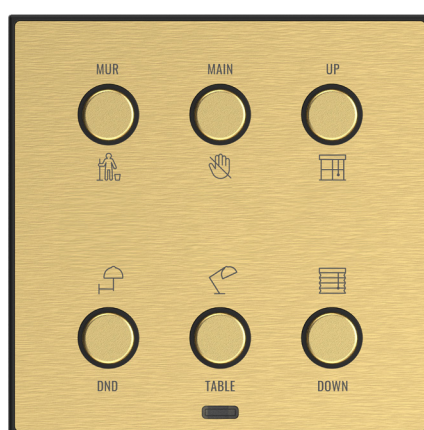

Satin Brass / 6 buttons



Graphite Black / 9 buttons

The white backlighting of the buttons, whose function and brightness can be defined by software, adds an even higher level of comfort to the chosen design. The panels can be freely customized with icons and text – see [icons.inels.com](https://icons.inels.com) configurator.

Make your design:  
**[icons.inels.com](https://icons.inels.com)**

## Integral part of the control panels

Socket panels are an essential part of every hotel room's controls. They replicate the designs of the glass GSB and metal MSB controllers. Various device modules can be inserted into the frames : 110/230V multistandard socket, USB A+C, HDMI, LAN, PIR and others. You can thus create combinations to suit your wishes, whether for your bed, TV or desk.

### Glass plates finishes

### Metal plates finishes

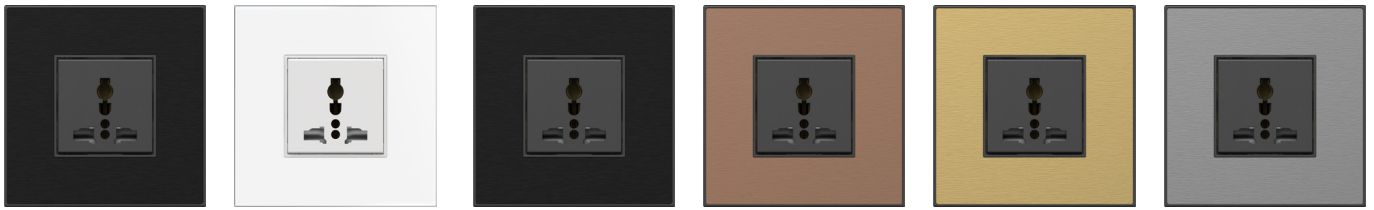

GSS3-PMS/B

GSS3-PMS/W

MSS3-PMS/B

MSS3-PMS/C

MSS3-PMS/G

MSS3-PMS/S

B - Black glass

W - White glass

B - Graphite black

C - Antique copper

G - Satin brass

S - Brushed silver

For the design variants, the PMS multistandard socket in matt black is used. These devices are available in polar white and matt black. The hole in the GSS3/MSS3 can be filled with a 2Module accessory or 2x 1Module. A 1Module blind cover is available.



Blind cover  
1-module



PIR  
1-module



USB A+C  
1-module



HDMI  
1-module



LAN  
1-module

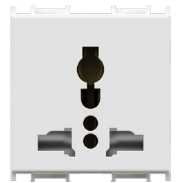

Multistandard socket  
2-modules

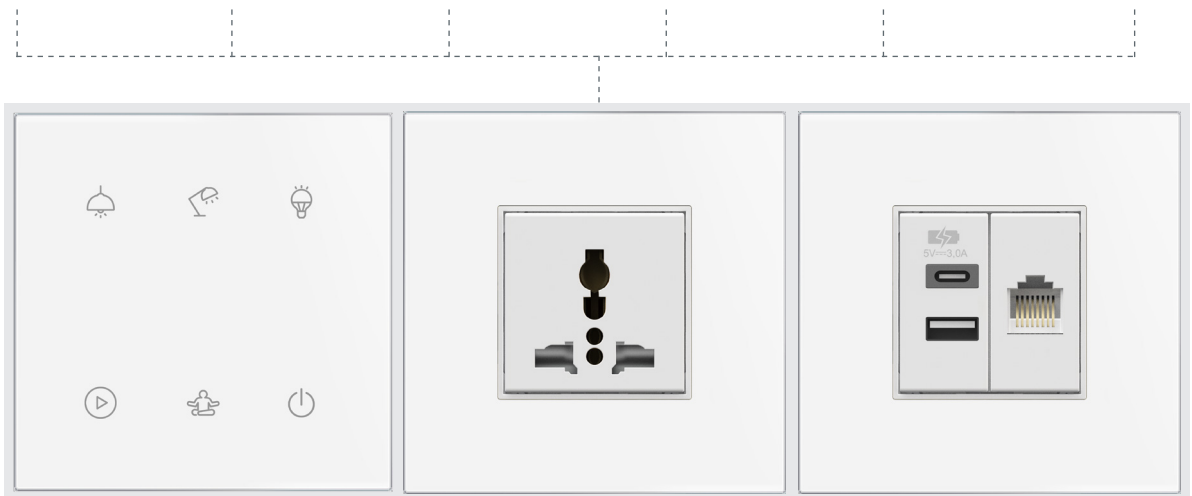

Glass switch buttons  
with symbols

AC power multistandard  
socket PMS

USB-A+C sockets & LAN RJ45



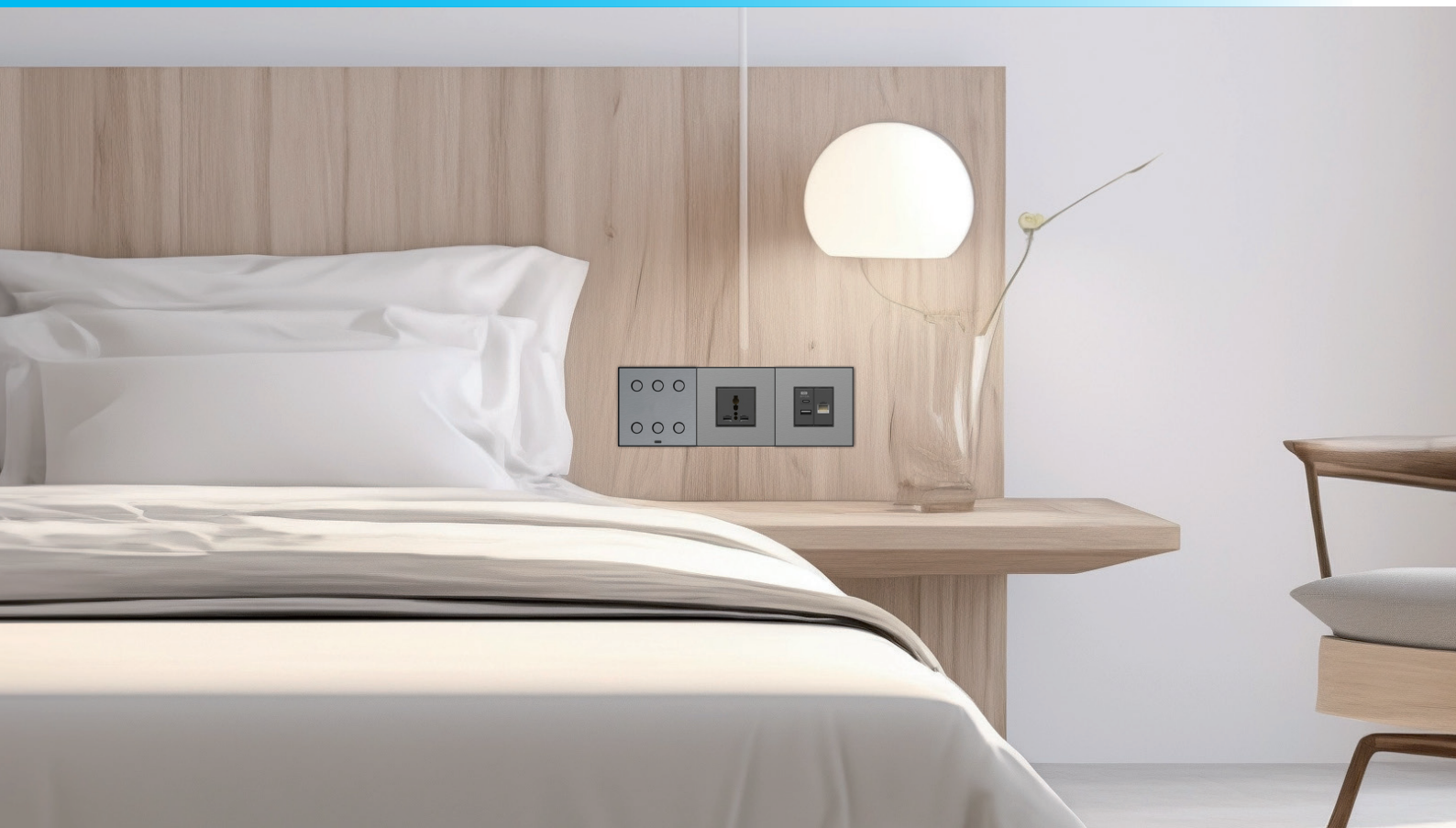

Blind cover  
1-modul



PIR  
1-modul



USB A+C  
1-modul



HDMI  
1-modul



LAN  
1-modul

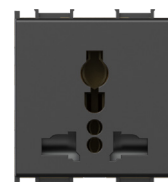

Multistandard socket  
2-modules

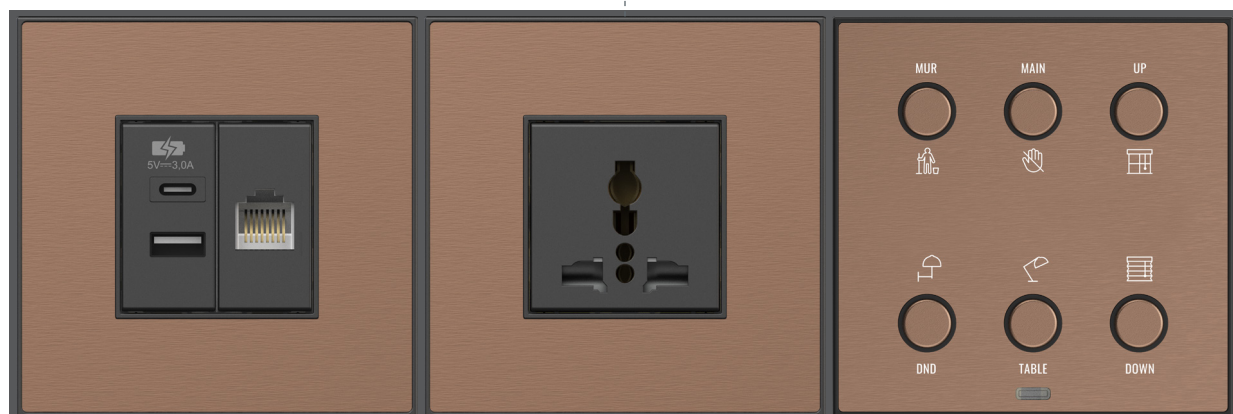

USB-A+C sockets & LAN RJ45

AC power multistandard  
socket PMS

Metal switch buttons  
with indicators

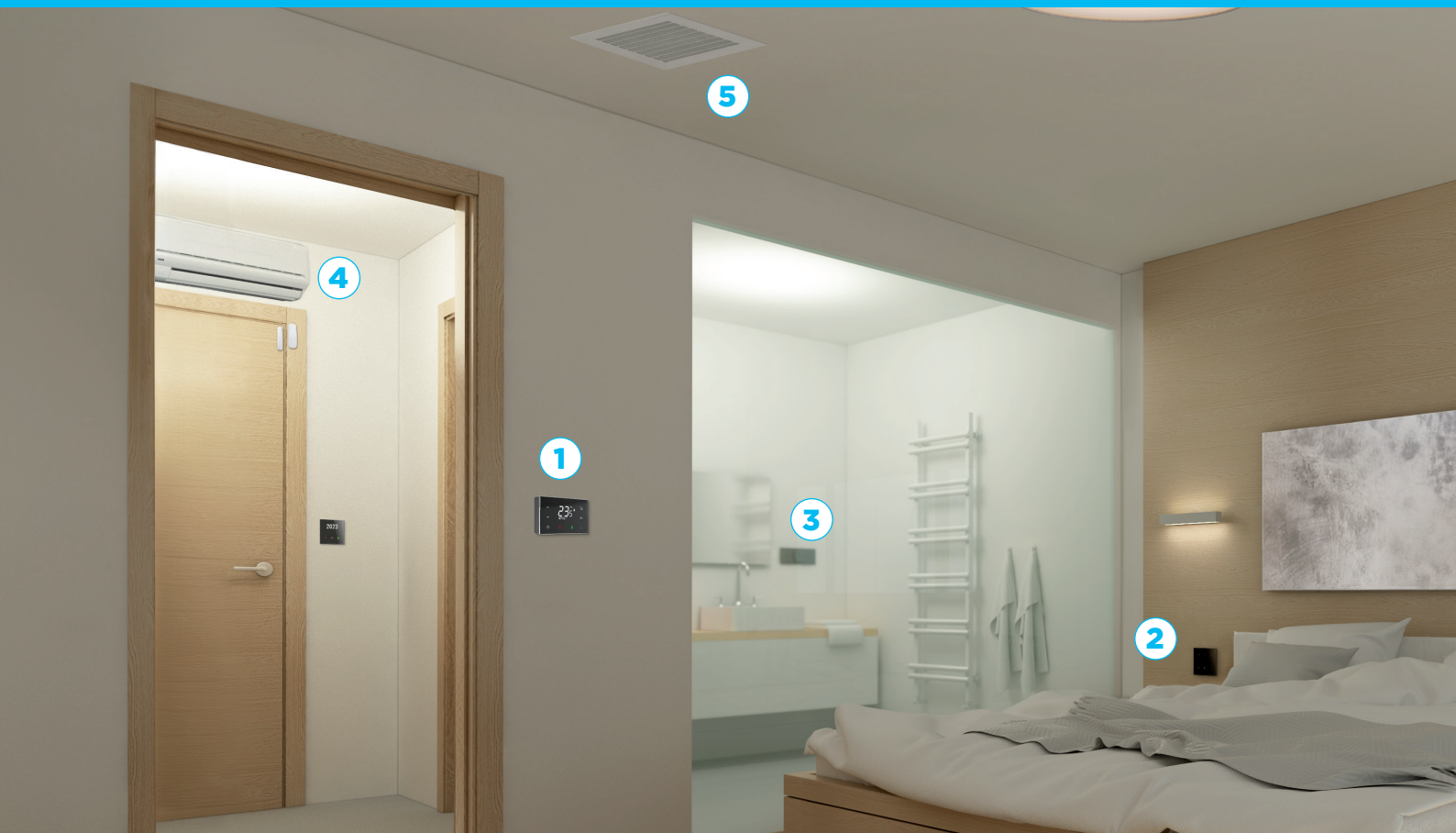

## Comfort requires the right temperature

Temperature control is an essential part of every hotel room. iNELS thermostats are intuitive for guests and can control 2 and 4 pipe fan coils, central heating radiators or electric floor heating. They work with the most commonly used air conditioning and VRV systems. They have been developed with a focus on energy saving where they set the correct thermal mode together with other detectors (window, door, motion) and save at the same time. Central temperature control from a monitoring centre or reception is also an option.

WALL MOUNTED



## Glass Thermostat for Fancoils

GRT3-100

Glass thermostat with output relays for direct switching of fan coils. Connection and power supply via iNELS BUS, configuration via iDM. Control of temperature, heating/cooling mode, fan speed and MUR/DND. Surface mounting, glass colour white or black. Built-in temperature, humidity and proximity sensor that activates backlighting of display and buttons at night.





2

**FLUSH MOUNTED**

2

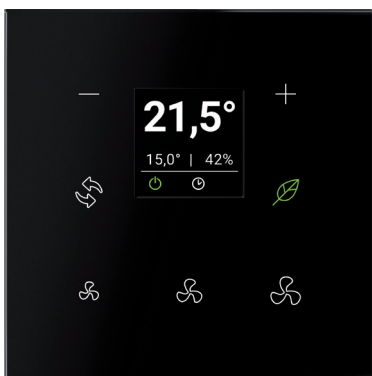

### Glass Room Thermoregulator

GRT3-70/B

Glass thermostat for correction of heating circuits defined in iDM. Connection and power supply via iNELS BUS or MODBUS. Temperature and mode control. Installation in EU/BS installation box, glass design white/black, sharp/round corners. Built-in temperature, humidity sensor. Terminals for connection of external temperature sensor.

**LOGUS<sup>90</sup> DESIGN**

3

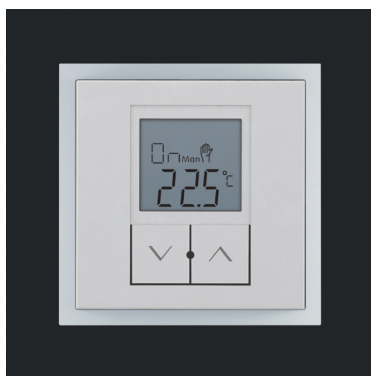

### Simple Room Thermoregulator

IDRT3-1

Simple plastic thermostat for correction of heating circuits defined in iDM. Colour combinations of covers and frames within the wide Logus90 range. Built-in temperature sensor and input for external temperature sensor TC/TZ.

5



### A/C control

ACI-ETH

It is used to connect the iNELS system with the most common types of air conditioners. It connects to the communication bus of the indoor split unit and to the system via Wifi using the MQTT protocol.

4

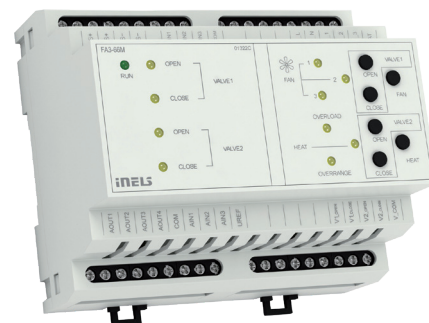

### Fancoil Unit Controller

FA3-612M

Actuator is used to control fancoil's units via an analog / digital inputs. Analog inputs are for temperature measurement, voltage or current. Connection is to installation BUS.



iNELS Hospitality offers a simple HRS (Hotel Reception Software) console that allows you to monitor the status of the room, including occupancy, MUR/DND and also allows you to control some of the functions: temperature, lighting, welcome scene. The software can be installed on a separate hotel server or it can be used in a Cloud version online.

Also included is a smart phone app for housekeeping that provides information on occupancy and cleaning requests.



### Room control card

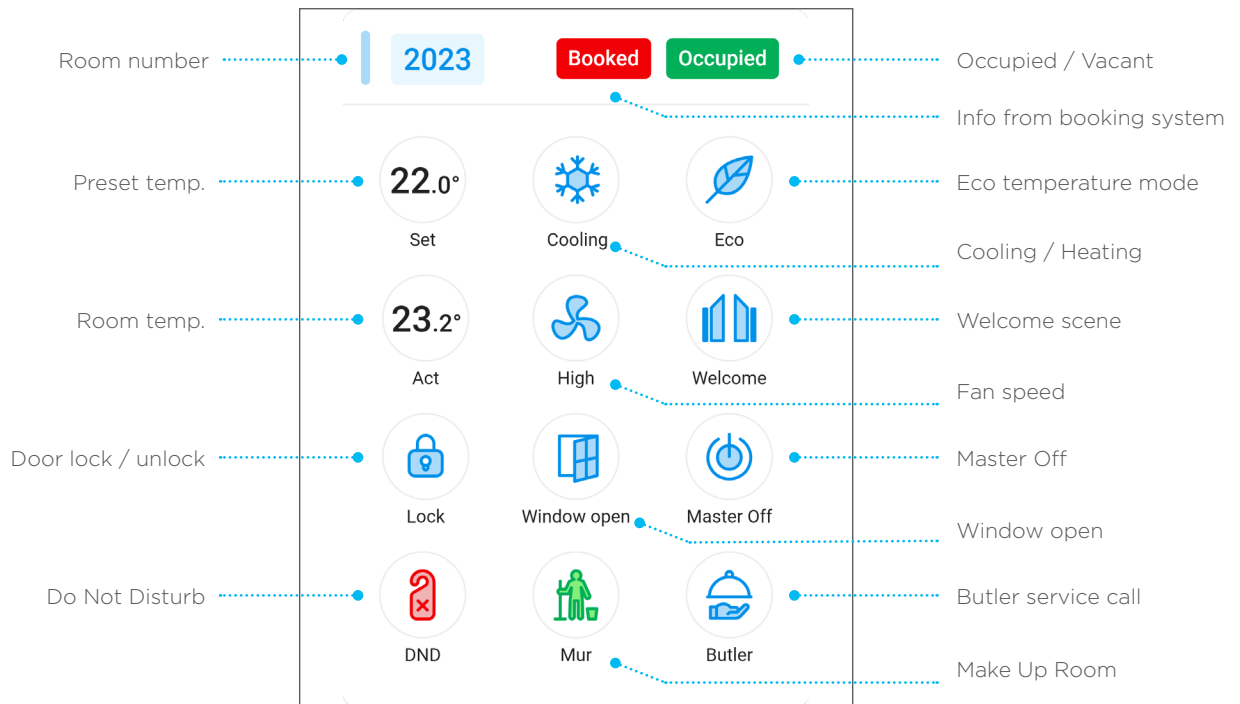

### Floor overview

The floor overview interface displays a grid of room control cards for the 1st floor. Room 203 is highlighted in blue. The interface includes a sidebar with navigation options (Dashboard, Devices, Rooms, Scenes, Log, Conditions, Reception, Settings, Log out) and a user profile for pet.hulinsky. A floorplan on the right shows the layout of the floor. A control center at the bottom right shows the set temperature (22.0°), heating state (Heating), and mode (Auto). A notifications section lists recent events for rooms 101, 103, and 105.

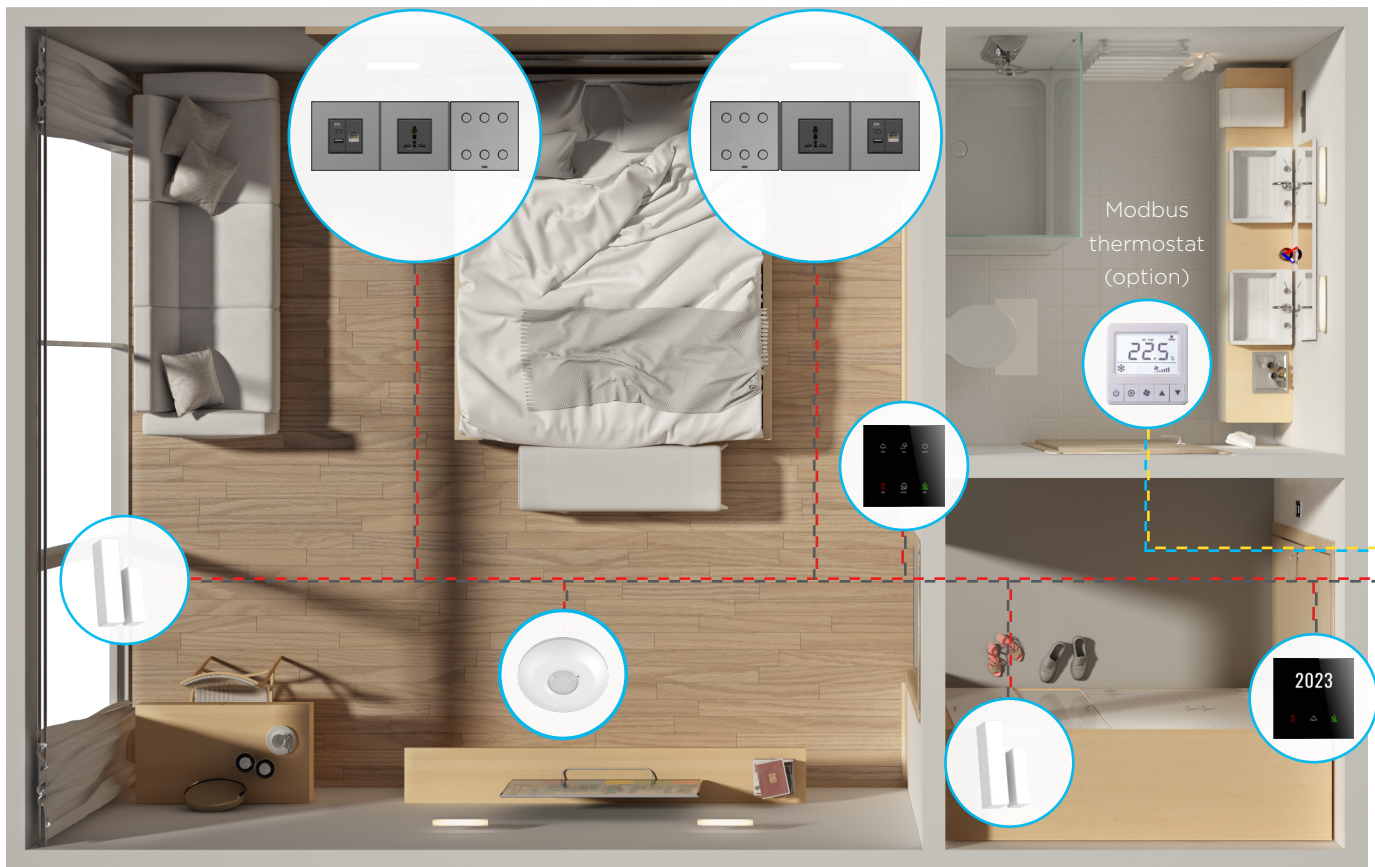

**The iNELS GRMS includes a unique solution of units in the panel on DIN rail: in a minimal size covering all needs and requirements.**

The heart of the system is the miniCU central unit, which includes an iNELS BUS for connecting up to 32 BUS units, a MODBUS bus for connecting thermostats and fancoils (if used) and a LAN port for IP connection to the higher-level system. It is also an MQTT gateway and firewall for security and protection of data transmissions.

Switching and dimming is then provided by a combined I/O unit which offers: 8x relay contacts for switching lighting or Relay 1 - Relay 5 can be used for switching fan coils, 6x digital inputs of which 2 can be used for connecting temperature sensors, 2x analogue outputs and last but not least a DALI master for dimming/dimming up to 16 DALI devices (DALI ballasts).

Together with the power supply, this powerful and compact backend occupies a width of only 10 modules on a DIN rail in a rack, while providing enough capacity to control a presidential suite.



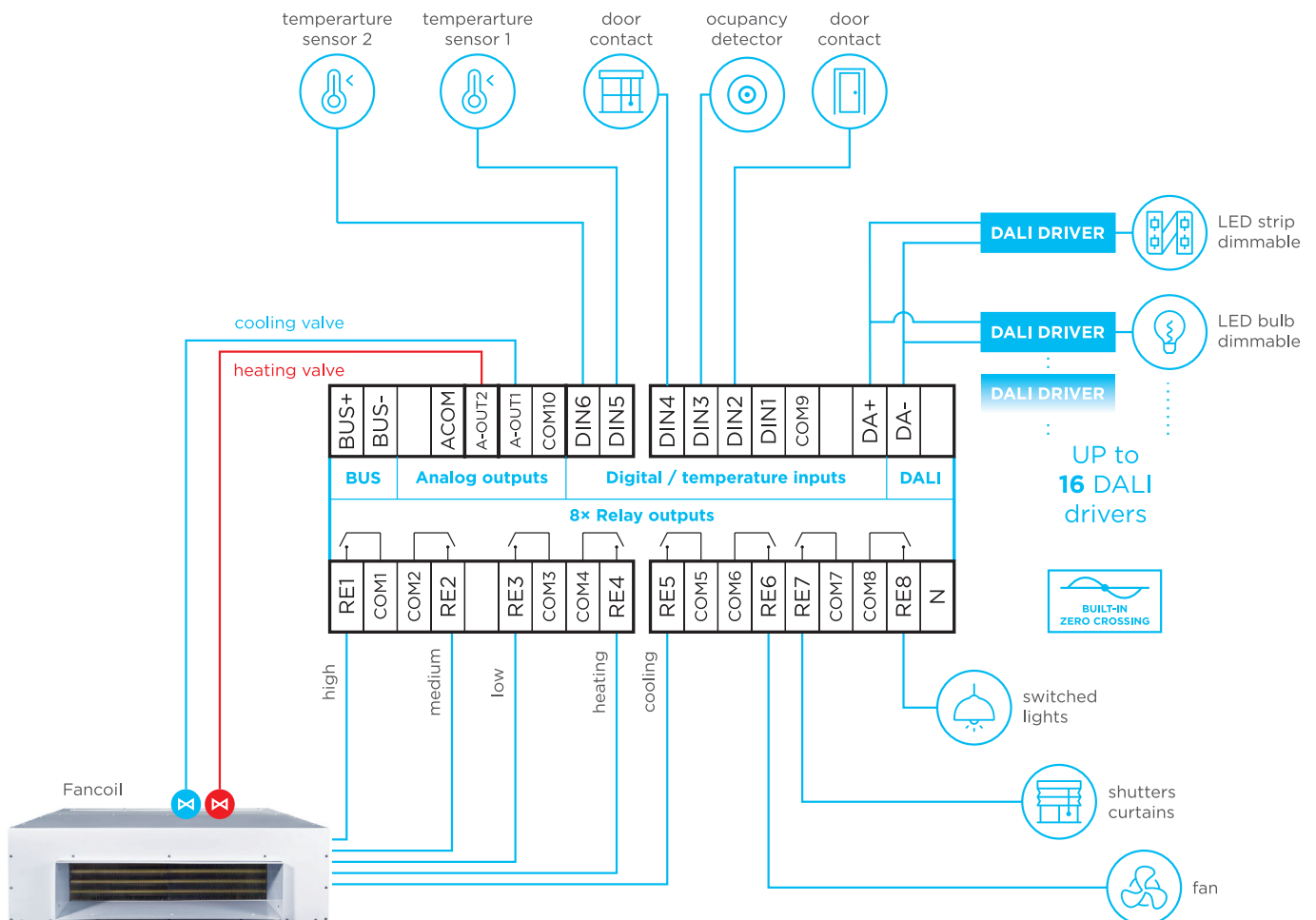
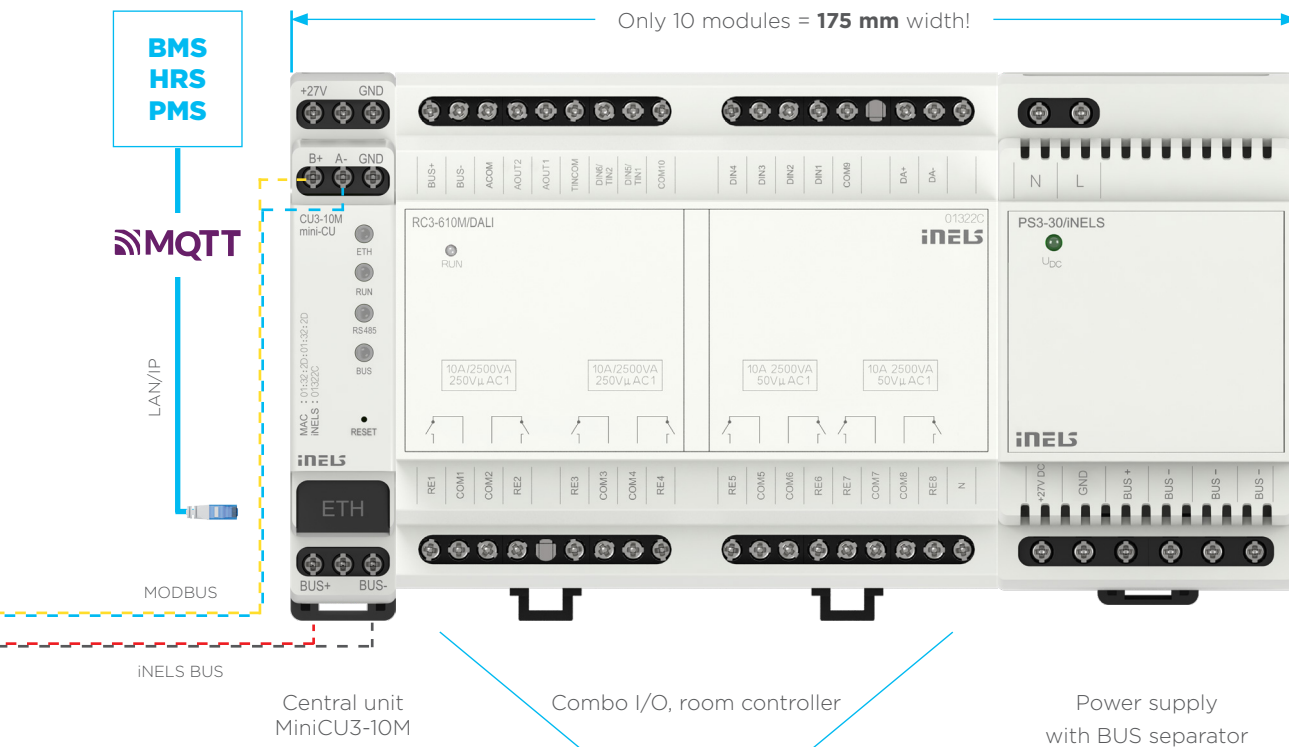

Part of iNELS Hospitality is LARA - internet radio and music player. Connection and power supply is provided by LAN with PoE, control is possible by touch buttons or via phone application. The device also includes a 2x10W amplifier, the power of which is sufficient for sounding a bathroom or even a room. The design of the enclosures and frames can be matched with Logus90, which also offers speakers for multiple frames.



**Music & Power Kit**

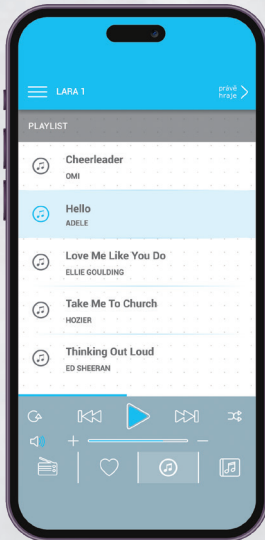

**App LARA Dio**

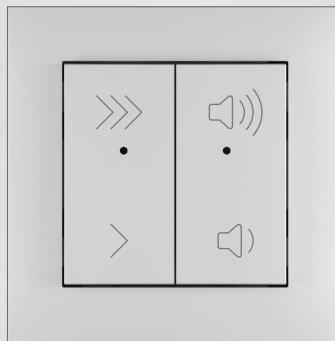

**Additional Control Button**





Thanks to the iNELS app for Samsung's Smart Hospitality TV, you can control the temperature, lighting, request cleaning or select do not disturb mode from the hotel room TV screen.

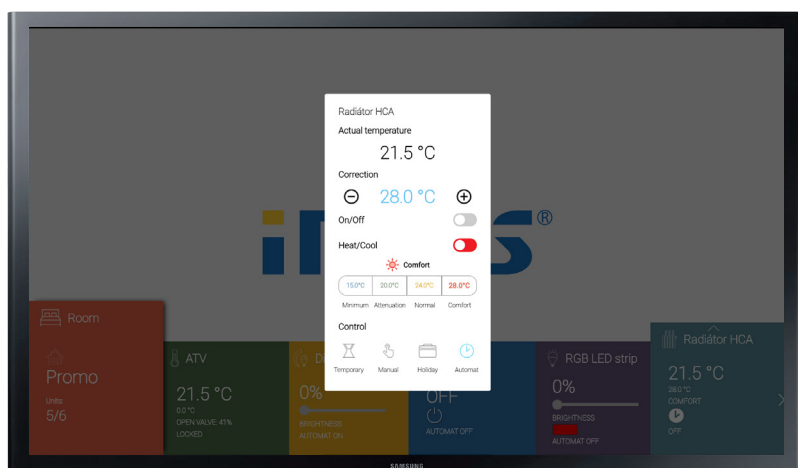
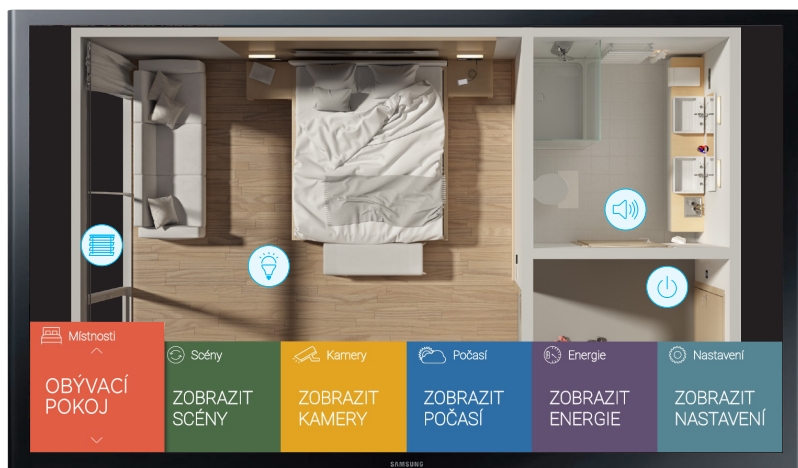

## Room Control

Hotel managers can easily manage and arrange the channel mix for both analogue and digital channels without the need to adjust and edit channel lists by different TV systems. Channels can be reordered and renamed to the hotel's preference with channel mapping.



Lights



Temperature control



Music



TV



Movie on demand



Integration with door lock manufacturers is a matter of course. Thanks to the interconnection, we receive information about the first entry into the room (triggering of the Welcome scene) and information about the occupancy of the room together with the motion detector in the iNELS system.

The room occupancy has a major influence on the energy management in the room, where it is possible to switch off all lights (or other electrical appliances) and set the attenuation temperature.

\* The picture of device is illustrative, the icons (symbols) are configurable by the customer.





LAN IP

iNELS Bridge



BUS

NFC

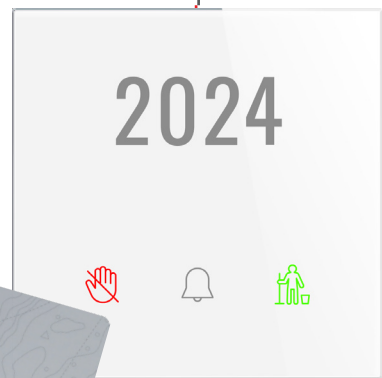
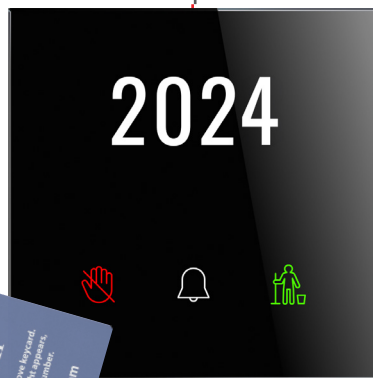

\*

### iNELS Digital Key

This smartphone app with a digital key (IDK) is another smart way how to unlock your room if you don't have a card with you.

### Glass Card Reader GCR3-30/SB

The RFID card reader is a great design for the entrance to the rooms which also features a bell signal the "Do Not Disturb" and "Make Up Room" signs and backlit room number. Thanks to the integrated relay it can control the door lock directly.

Card type: Mifare 1k, 4k, Ultralight, DesFire, ISO/IEC 14443-4 (CD97BX, CD light, P5CN072 (SMX) Innovision jewel (IRT5001), FeliCa (RCS\_860, RCS\_854)

Frequencies: 13,56 MHz

### Glass Card Reader GCR3-30/SW



Common areas - such as corridors, reception, lobbies, restaurants, bars, wellness and related facilities are an integral part of every hotel. Here too, lighting and temperature must be controlled, usually according to a different mode. Part of iNELS GRMS are units that can control multiple circuits or more power.

For example, the DA3-66M dimmer can dim up to 6 independent dimmable circuits, the SA3-22M switching actuator can switch up to 22 relay outputs or the CU3-09M can control up to 64 DALI addressable dimmable luminaires. This will undoubtedly have a positive effect on the purchase price of the entire system.

Just like the controls, the power elements follow the latest technological trends: switching output relays with ZERO-CROSS make it possible to switch even current-consuming LED lighting - unless you prefer to directly select dimmers with DALI interface, which are included in both versions of the iNELS Hospitality system.





6x  
DIMM



## Phase dimm up to 6 circuits

### DA3-66M Dimmer

The RC3-610M/DALI is an I/O actuator equipped with 6 binary inputs, of which 2 can be configured as temperature inputs and 8 independent relays with switching potential-free and potential contacts.

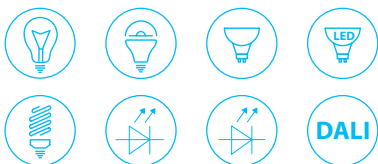

14x  
SWITCH



## Switching actuator for 14 units

### SA3-014M Switching actuator

The actuator is designed for switching various appliances and loads with Zero Crossing technology.



64  
DALI ADDRESS

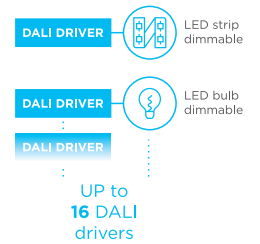

## Central unit for DALI

### CU3-09M-DALI

CU3-09M is a control unit in INELS BUS installations, working independently or as part of a larger project. It includes one BUS line, it can connect up to 32 INELS BUS elements and includes a DALI bus for controlling up to 64 DALI ballast addresses. The unit employs MQTT for third-party communication and supports direct cloud communication for mobile app control.

Central units



**CU3-08M**  
Central unit  
with 2x BUS,  
max. 64 units



**CU3-09M/DALI**  
Central unit  
with 1 BUS, 1x DALI,  
with 64 DALI addresses



**CU3-10M**  
Central unit  
with 1x BUS,  
1x MODBUS

Detectors | sensors



**MCD3-01**  
Ultra slim microwave  
motion detector - ceiling  
mount



**PMS3-01**  
Ultra slim PIR motion  
detector - ceiling mount

Input units



**IM3-40B**  
Binary input unit,  
4 inputs



**IM3-80B**  
Binary input unit,  
8 inputs



**IM3-140M**  
Binary input unit,  
14 inputs



**TI3-40B**  
Temperature input,  
4 inputs



**TI3-60M**  
Temperature input,  
6 inputs

Switching actuators



**SA3-01B, SA3-02B**  
Switching actuator,  
1 channel and 2  
channels



**SA3-04M**  
Switching  
actuator,  
4 channels



**SA3-06M**  
Switching  
actuator,  
6 channels



**SA3-014M**  
Switching actuator,  
14 channels



**SA3-014M/E**  
Switching actuator,  
14 channels (without  
manual control  
buttons and RE  
status LED)



**SA3-022M**  
Switching actuator,  
22 channels



**EA3-022M**  
Switching actuator  
without controls and  
indicators,  
22 channels



## Power supplies



**PS3-30/iNELS**  
Power supply  
with integrated BUS  
separator



**BPS3-01M,  
BPS3-02M**  
Bus separator  
from power supply



**PSM3-30/iNELS**  
Power supply  
for iNELS BUS



**PSM3-60/iNELS**  
Power supply  
for iNELS BUS



**PSM3-100/iNELS**  
Power supply  
for iNELS BUS

## Lighting control



**DA3-22M**  
Universal dimming  
actuator,  
2 channels



**DA3-66M**  
Dimming actuator,  
6 channels



**DA3-03M/RGBW**  
Dimming actuator  
for RGBW strips

## Shutter actuators



**JA3-014M**  
Shutter actuator,  
14 channels



**JA3-014M/E**  
Shutter actuator,  
14 channels (without  
manual control  
buttons and RE  
status LED)

## Combined units

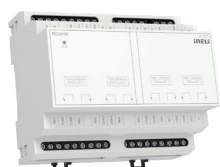

**RC3-610M/DALI**  
Room controller  
with DALI dimmer



**FA3-612M**  
Fancoil controller

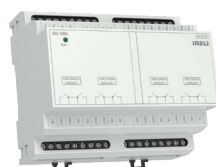

**IOU3-108M**  
Universal unit with  
10 inputs and 8 outputs

Wall controllers, LOGUS<sup>90</sup> design

Card readers

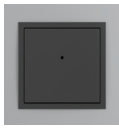

**WSB3-20, WSB3-20H**  
Wall switch button,  
2 buttons

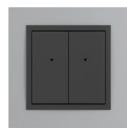

**WSB3-40, WSB3-40H**  
Wall switch button,  
4 buttons

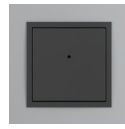

**WMR3-21**  
Wall card reader



**GCR3-30**  
sharp  
Glass card reader



**GCR3-230**  
round  
Glass card reader

Glass controllers

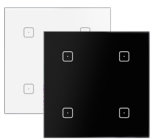

**GSB3-40**  
sharp  
4 buttons

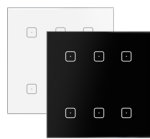

**GSB3-60**  
sharp  
6 buttons

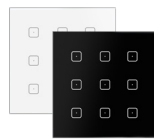

**GSB3-90**  
sharp  
9 buttons



**GSB3-240**  
round  
4 buttons

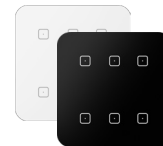

**GSB3-260**  
round  
6 buttons

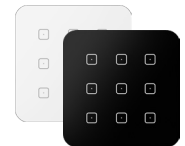

**GSB3-290**  
round  
9 buttons



**GSB3-40/S**  
sharp  
4 buttons,  
with symbols

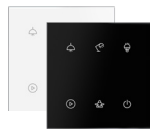

**GSB3-60/S**  
sharp  
6 buttons,  
with symbols

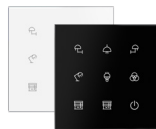

**GSB3-90/S**  
sharp  
9 buttons,  
with symbols



**GSB3-240/S**  
round  
4 buttons,  
with symbols



**GSB3-260/S**  
round  
6 buttons,  
with symbols



**GSB3-290/S**  
round  
9 buttons,  
with symbols

Metal controllers

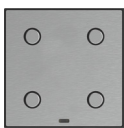

**MSB3-40/SS**  
Brushed silver  
4 buttons

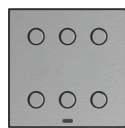

**MSB3-60/SS**  
Brushed silver  
6 buttons

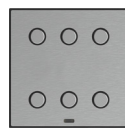

**MSB3-90/SS**  
Brushed silver  
9 buttons

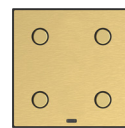

**MSB3-40/GG**  
Satin brass  
4 buttons

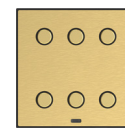

**MSB3-60/GG**  
Satin brass  
6 buttons

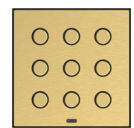

**MSB3-90/GG**  
Satin brass  
9 buttons

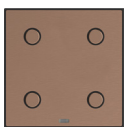

**MSB3-40/CC**  
Antique copper  
4 buttons

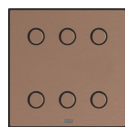

**MSB3-60/CC**  
Antique copper  
6 buttons

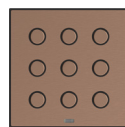

**MSB3-90/CC**  
Antique copper  
9 buttons

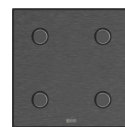

**MSB3-40/BB**  
Graphite black  
4 buttons

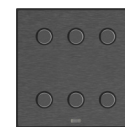

**MSB3-60/BB**  
Graphite black  
6 buttons

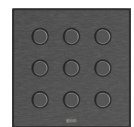

**MSB3-90/BB**  
Graphite black  
9 buttons



## Thermo-regulators



**IDRT3-1**  
Digital room  
thermo-regulator



**GRT3-70**  
sharp  
Glass room  
thermo-regulator



**GRT3-270**  
round  
Glass room  
thermo-regulator



**GRT3-100**  
Glass room on-wall  
thermo-regulator with  
relays for fancoils control

## Touch units



**EST4**  
4" touch  
control panel



**EST8**  
8" touch  
control panel



**EST10**  
10" touch  
control panel



## Integration



**iNELS Bridge**  
Third-party integration  
gateway



**Connection Server II.**  
Third-party integration  
server

## Multimedia



**LARA Radio**  
Player Internet radio

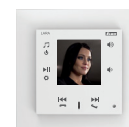

**LARA Intercom**  
Multifunction communication  
equipment

## iNELS app



New application for controlling all compatible  
elements from the iNELS portfolio.

## Accessories



**TELVA-2 230V,**  
**TELVA-2 24V**  
Thermodrive



**AN-I, AN-E**  
Internal antenna  
External antenna



**TC, TZ, Pt100**  
Thermo sensors





BACKEND

FRONTEND

HRS

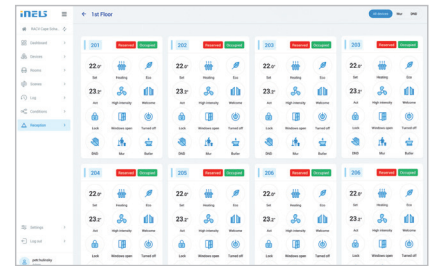
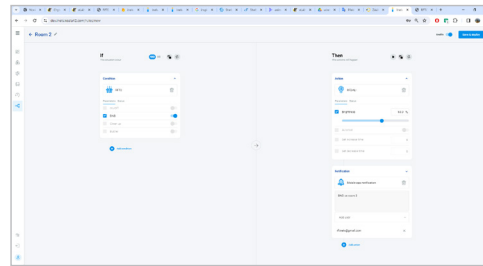

NodeRED

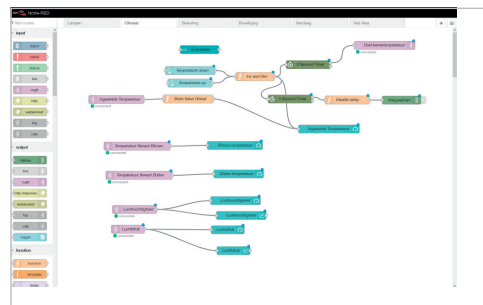

SkyThings

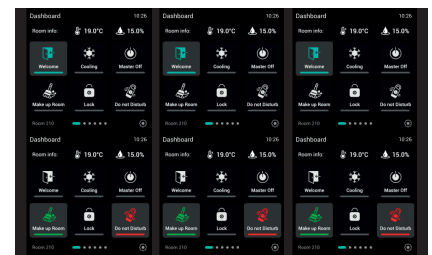
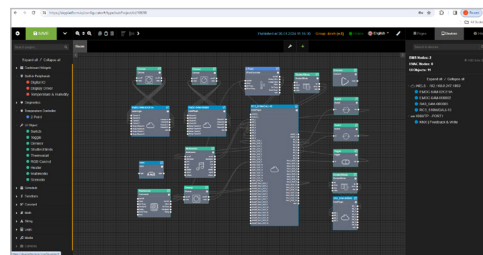

PMS





Online customization:  
[icons.inels.com](https://icons.inels.com)



ELKO EP as a manufacturer has technologies that allow us to offer you a wide range of customization: colors of controls, shapes of glass, icons and button descriptions, including hotel room numbers and even hotel logos. Special and unusual combinations can be made on request.

We can supply the entire order with elements pre-programmed from the factory so that you only install them according to their codes in the correct room numbers. This will significantly reduce programming and commissioning costs.

ROUND  
SHARP

black white background options

custom icons

custom text

hotel logo

BEDSIDE LAMP MAIN LIGHT BEDSIDE LAMP

UP DOWN ON / OFF

DND BUZZER MUR

**HOTEL LOGO**



## Icon library

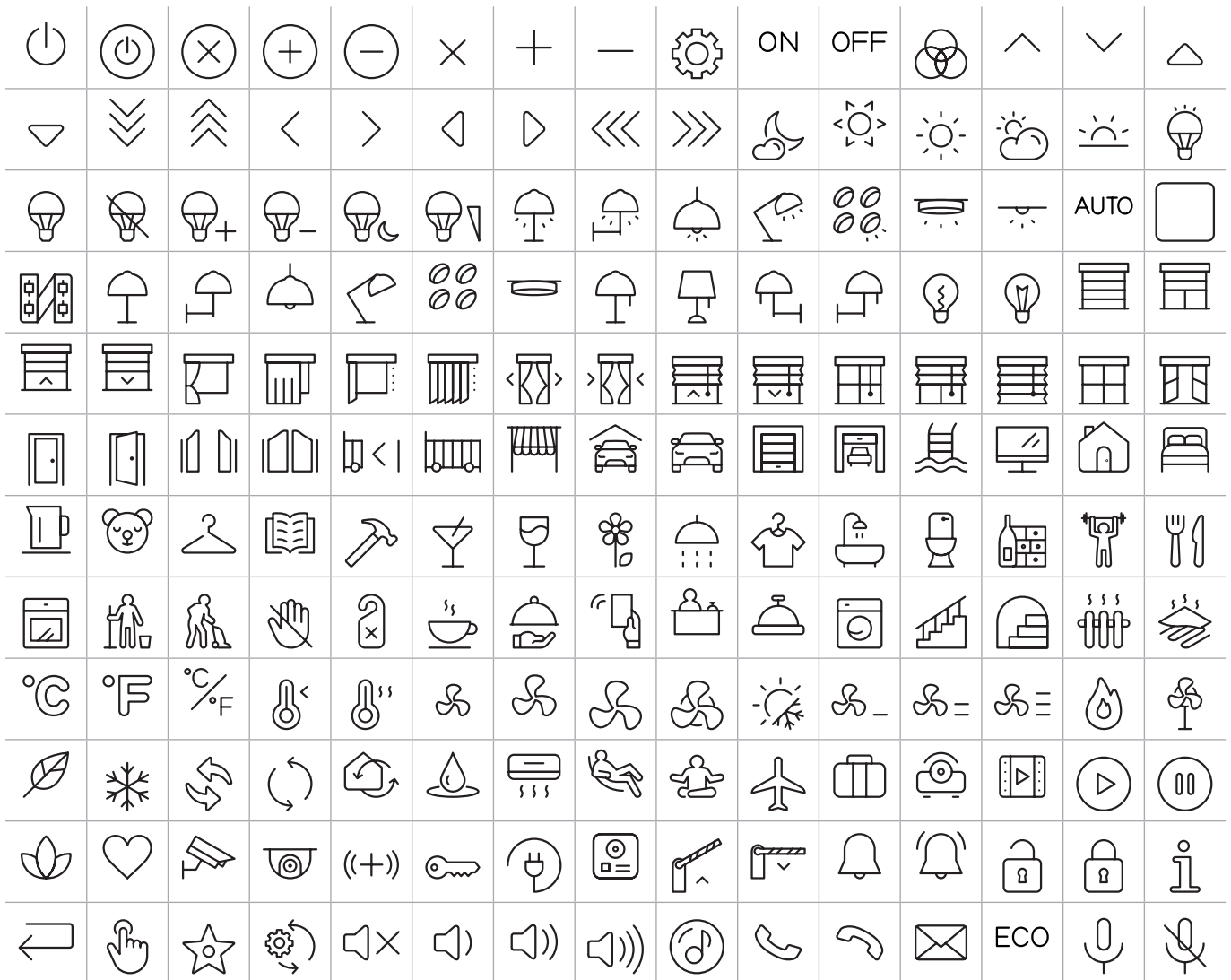



## Controllers – natural & plastic



**RFWB-20/G** – white  
**RFWB-20/GB** – black  
On-wall button controller  
– 2 buttons

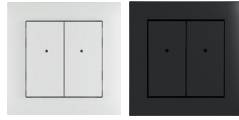

**RFWB-40/G** – white  
**RFWB-40/GB** – black  
On-wall button controller  
– 4 buttons

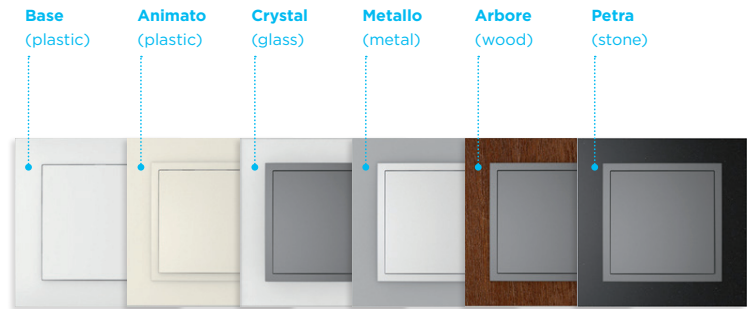

## Controllers – glass



**RFGB-20/W** – white  
**RFGB-20/B** – black  
Glass touch controller  
SHARP – 2 buttons

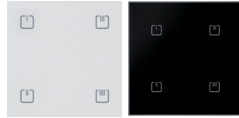

**RFGB-40/W** – white  
**RFGB-40/B** – black  
Glass touch controller  
SHARP – 4 buttons



**RFGB-220/W** – white  
**RFGB-220/B** – black  
Glass touch controller,  
ROUND – 2 buttons



**RFGB-240/W** – white  
**RFGB-240/B** – black  
Glass touch controller,  
ROUND – 4 buttons

## Controllers – glass with actuators



**RFSW-62/B** – black glass, SHARP  
**RFSW-262/W** – white glass, ROUND  
Glass touch controller  
with output relays



**RFDW-71/B** – black glass, SHARP  
**RFDW-271/W** – white glass, ROUND  
Glass touch controller  
with dimmer

## Courtesy units – glass with symbols

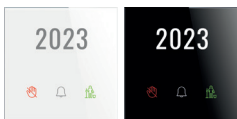

**RFGS-30/SB** – black glass  
**RFGS-30/SW** – white glass  
Infront of door hotel  
room unit



**RFSW-62/SB** – black glass  
**RFSW-62/SW** – white glass  
Wireless touch glass remote  
control with symbols and two  
output relays

## Switch units – flush mounted



### RFS-61B

Switch unit, 1 channel  
– 1x 16 A, multifunction



### RFSAI-61BPF-SL

Multifunction switch unit  
with inputs for external  
buttons – 1x 8 A, with galva-  
nically separated contacts



### RFSAI-61B-SL

Multifunction switch unit  
with inputs for external  
buttons – 1x 8A



### RFSAI-62B-SL

Multifunction switch unit  
with inputs for external  
buttons 2-channels, 2x 8 A  
(total)



### RFJA-32B-SL

Switch unit for shutters,  
2x 8 A

## Switch units – DIN rail mounted



### RFS-61M

Switch unit, 1 channel – multi-  
function, 1x 16 A



### RFS-66MI

Switch unit, 6 channels with  
integrated antenna  
– multifunction, 6x 8 A



### RFS-61MI

Switch unit, 1 channel with  
integrated antenna  
– multifunction, 1x 16 A



### RFS-66M

Switch units, 6 channels  
– multifunction, 6x 8 A

## Dimmers – flush mounted



### RFDAC-71B-SL

Analog controller,  
0(1)-10 V  
– multifunction



### RFDALI-32B-SL RFDALI-04B-SL

DALI controller,  
for 4/32 DALI addresses



### RFDEL-71B-SL

Phase dimmer  
1-channel – 1x 300 VA  
– R, L, C, LED, ESL

## Dimmers – DIN rail mounted



### RFDA-73M/RGBW

Dimmer for LED (RGB) strips,  
3-channels



### RFDEL-71M

Universal dimmer,  
1-channel – 1x 600 VA  
– R, L, C, LED, ESL



### RFDEL-76M

Universal dimmer,  
6-channels – 6 x 150 VA

## Temperature control



**RFTC-3**  
Glass touch thermostat for fancoils



**RFTC-4**  
Glass touch battery powered



**RFTC-50/G**  
Autonomous temperature controller



**RFTC-10/G**  
System temperature controller



**TC TZ**  
External temperature sensors



**RFATV-2**  
Wireless thermostatic valve



**RFTI-20**  
Temperature and humidity sensor



**RFSA-266M**  
Switch unit for fancoil control



**RFSTI-11B-SL**  
Switch unit with external temperature sensor

## Converters



**RFIM-40B/BP-SL**  
4 input contacts converter battery powered



**RFIM-40B/230-SL**  
4 input contacts converter AC 230 power supply



**RFSG-1M**  
Input contact converter -1x permanent contact

## Detectors



**RFMD-200**  
Motion detector



**RFMD-100**  
Motion detector corner mounted



**RFWD-100**  
Window/Door detector



**RFSF-100**  
Flood detector



## System units



**eLAN-RF-103**  
Smart RF gateway  
with LAN



**RFRP-20N**  
Repeater to extend  
the range



**RF Touch-2/BE**  
**RF Touch-2/BR**  
Wireless touch unit  
– flush mounted

## Accessories



**RFAF/USB**  
Service Key



**AN-I**  
Internal antenna  
Gain: 2.1 dBi



**AN-E**  
External antenna  
Gain: 5 dBi



**AN-E3**  
External antenna  
Gain: 3 dBi, IP67



Extension cable for external  
antenna  
10 m

## Socket panels – metal frames

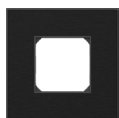

**MSS3/B**  
Graphite black

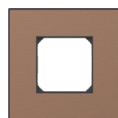

**MSS3/C**  
Antique copper

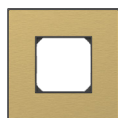

**MSS3/G**  
Satin brass

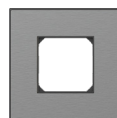

**MSS3/S**  
Brushed silver



**GSS3-B**  
Black glass



**GSS3-W**  
White glass

## Socket panels – glass frames

## Accessories



**VM55SB-U**  
Multistandard socket  
2-modules



**EM68SB-U**  
USB A+C  
1-modul



**KM35SB-U**  
HDMI  
1-modul



**KM39SB-U+**  
**KM50SB-U**  
LAN  
1-modul



**EM31SB-U**  
PIR  
1-modul



**TM21SB-U**  
Blind cover  
1-modul



**VM55SW-U**  
Multistandard socket  
2-modules



**EM68PW-U**  
USB A+C  
1-modul



**KM35PW-U**  
HDMI  
1-modul



**KM39PW-U+**  
**KM50PW-U**  
LAN  
1-modul



**EM31PW-U**  
PIR  
1-modul



**TM21PW-U**  
Blind cover  
1-modul

- 1** Infront of door hotel room unit  
RFBS-30/S, 24V/230V powered
- 2** Glass touch controller with symbols and two outputs  
RFSW-62/S, 24V/230V powered
- 3** Glass touch thermostat for fancoils  
RFTC-4, battery powered, control RFS-266 M
- 4** Motion detector for ceiling mounting  
RFMD-200, battery powered
- 5** Window/door detector  
RFWD-100, battery powered
- 6** Glass touch controller, 4 buttons  
RFG-40, battery powered
- 7** DALI controller, 4 DALI balast  
RFDALI-04/B-SL, 230V powered
- 8** Switch unit for fancoil control  
RFS-266M
- 9** USB/LAN socket panel  
GSS3-USB/LAN
- 10** AC power multistandard socket  
GSS3-PMS

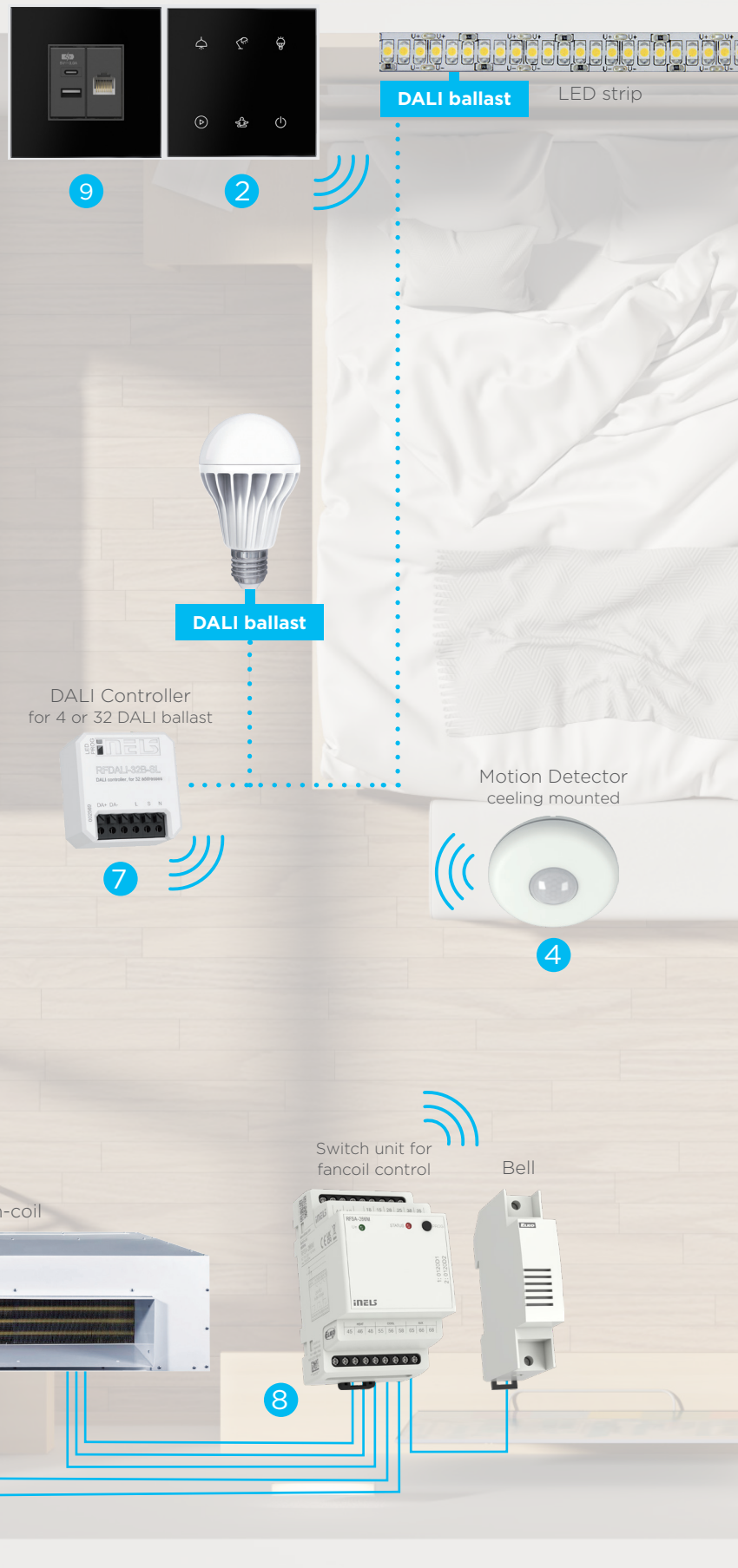

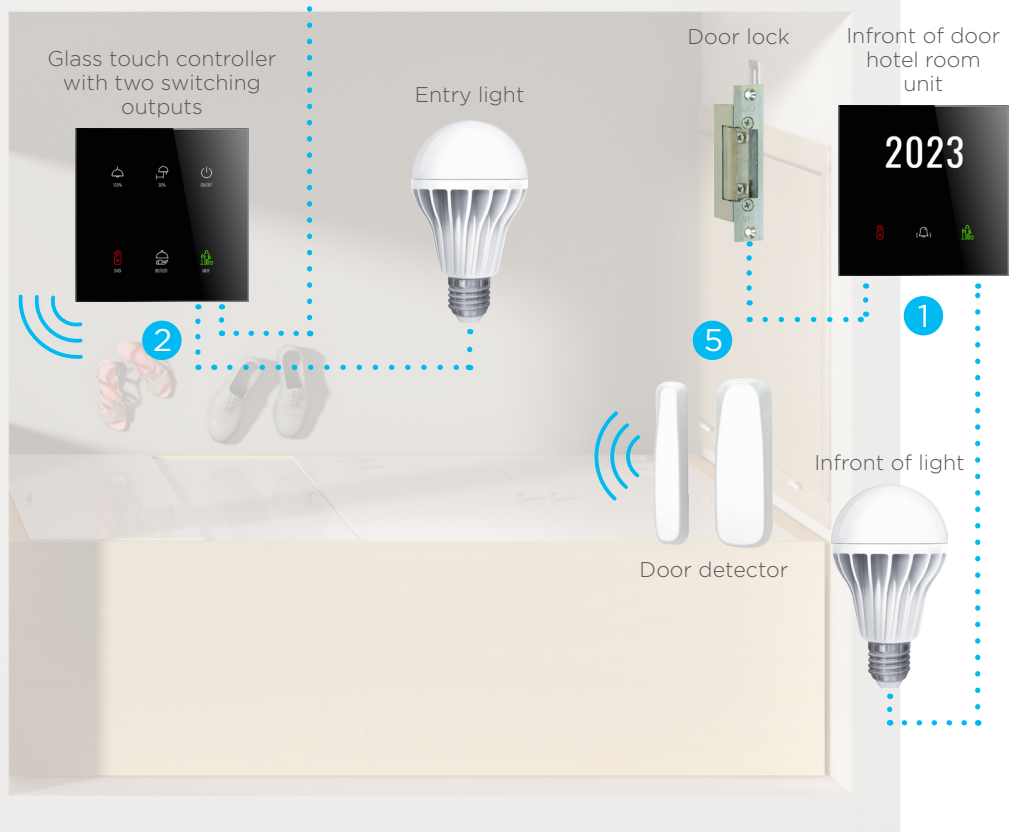
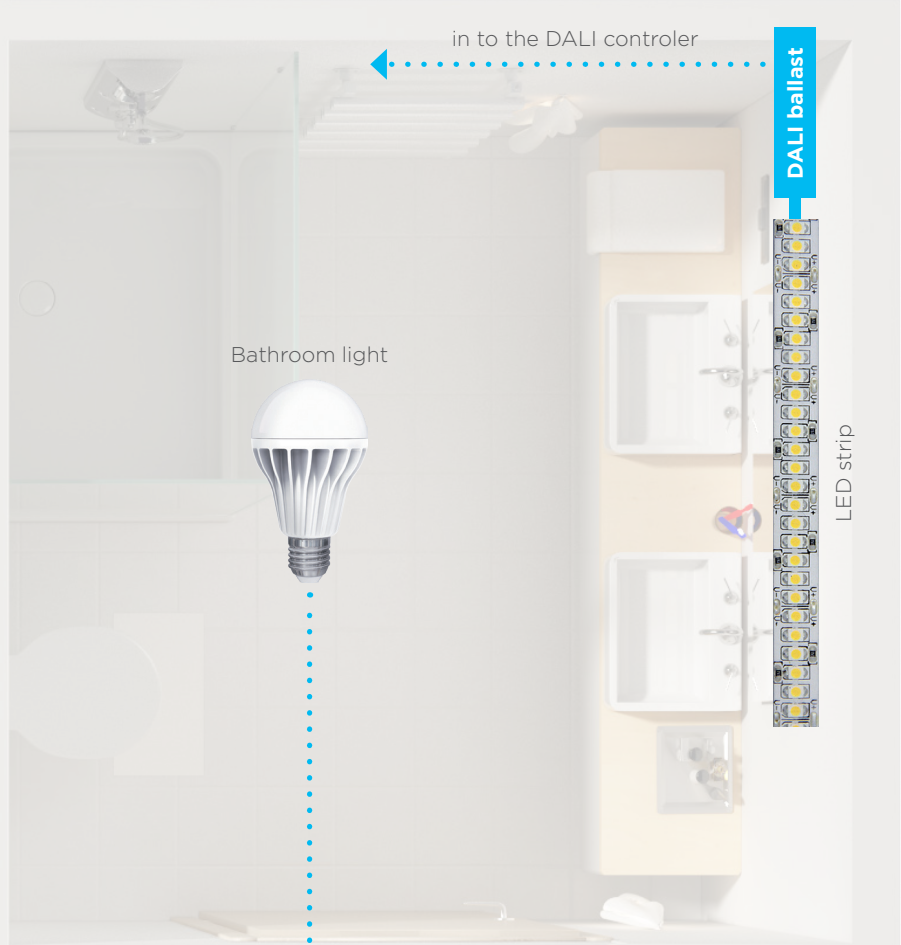



# REFERENCES

## Isla Mallorca

Mallorca, Spain



- 4-star hotel in Palma de Mallorca
- 10 floors, 154 rooms, wellness, bars, restaurant, meeting rooms
- lighting control, HVAC control
- exit button (switch OFF)

## Radisson Blu Ridzene Hotel

Riga, Latvia



- 7 lighting zones integrated in iNELS RF system
- sockets near beds for comfortable staying
- switches with laser-printed icons

---

## Marriott Marquis

Doha, Qatar



- 5-star hotel in the Doha City center
- 44 floors, 397 rooms, 182 suites,
- 18 meeting rooms
- lighting control
- HVAC control
- master switch OFF

## Rocks Hotel & Casino

Kyrenia, Cyprus



- 5-star hotel located close to historical city Kyrenia
- the lights are controlled in iNELS system via light panel
- USB socket, glass thermostats

### Wyndham Grand

Istanbul, Turkey



- lighting control in each room, the common areas, conference rooms and other spaces
- 3000 lighting circuits are controlled through the DALI protocol
- EMDC units

### Meydan

Dubai, UAE



- lighting control
- crystal chandelier
- starry night sky control
- audio/video system

### Movenpick

Dubai, UAE



- 255 rooms, 230000 sq,
- 530 units, 1600 light circuits
- control appliances, lights
- HVAC control
- garage doors, sockets

### Merit Royal Premium

Kyrenia, Cyprus



- 125 rooms
- complete management
- of hotel rooms
- scenes: arrival/departure
- and day/night
- Guest Room Hotel Management System

### Hotel Claude Marbella

Marbella, Spain



- modernization of 7 luxury rooms
- room scenes, automatic lighting
- controlling by using glass readers and card holders





● **Headquarters**

ELKO EP Holding SE, Czech Republic

---

● **Europe**

ELKO EP Balkan d.o.o  
ELKO EP Bulgaria OOD  
ELKO EP Germany GmbH  
ELKO EP Hungary Kft.  
ELKO EP POLAND Sp. z o.o.  
ELKO EP SLOVAKIA, s.r.o.  
ELKO EP UK Ltd.  
ELKO EP UKRAINE LLC

● **Africa & Middle East**

ELKO EP Egypt LLC  
ELKO EP Kuwait Ltd.  
ELKO EP MEA LLC  
ELKO EP Saudi Arabia Ltd.  
ELKO EP South Africa PTY Ltd.

● **America**

ELKO EP North America LLC

---



**ELKO EP, s.r.o.** | Palackeho 493 | 769 01 Holesov, Vsetuly | Czech Republic  
phone: +420 573 514 221 | fax: +420 573 514 227 | [elko@elkoep.com](mailto:elko@elkoep.com) | [www.elkoep.com](http://www.elkoep.com)

Published: 12/2023 | Modifications or amendments reserved | © Copyright ELKO EP, s.r.o. | 2<sup>nd</sup> edition